

## PRODUCT SPECIFICATION

# AQUACONNECT® C900 CERTA-LOK® FITTINGS

Westlake Pipe & Fittings produces Adapters, Expansion Couplings and Sweeps directly compatible with our AquaSpring® C900 Certa-Lok® pipe products.

For additional appurtenance needs, our AquaSpring C900 Certa-Lok pipe products can be mated to compatible Cast Iron Outside Diameter (CIOD) third-party fittings.

### Notes:

1. These dimensions are for estimating purposes only. All dimensions are in inches unless otherwise specified.
2. AWWA Pressure Class @ 73°F and includes 2:1 safety factor.
3. Expansion couplings do not provide a fully restrained joint.



Only products bearing the NSF Mark are Certified

### SHORT FORM SPECIFICATION

Pipe Standard:	AWWA C900
Diameter Std.:	Cast Iron Outside Diameter (CIOD)
Nominal Sizes:	4", 6", 8", 10", 12", 16"
Color:	Female Fittings – White Sweeps – Blue
Fitting Compound:	ASTM D1784 Cell Class 12454
Pipe Joint Std.:	ASTM D3139
Gasket Standard:	ASTM F477
Certifications:	NSF 61
Installation Std.:	AWWA C605

### C900/RJ TO C900/RJIB CERTA-LOK® ADAPTERS

Nom. Size	Pipe Outside Diameter	Pressure Rating (psi)	BOD	L	Weight (lb)	Part Number		
						Fitting*	Gasket	Splines
4"	4.800	305	5.964	8.250	4.0	82157862106	OR040RJOI	S0418SN0 S0518TN0

\* Includes gaskets and splines

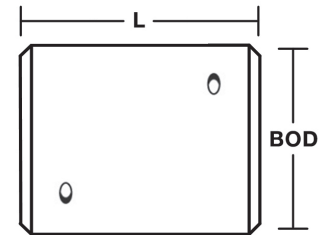

### C900 CERTA-LOK® EXPANSION COUPLINGS CERTA-LOK FEMALE X GASKETED SLIP JOINT

Nom. Size	Pipe Outside Diameter	Pressure Rating (psi)	Certa-Lok Groove Compatibility		BOD	L	C	Weight (lb)	Part Number		
			C900/RJ	C900/RJIB					Fitting*	Gasket	Splines
4"	4.800	305	Yes	No	5.964	18.000	9.200	8.9	82157292767	OR040RJOI	S0418SN0
6"	6.900	305	Yes	Yes	8.366	18.000	7.950	15.9	82157292774	OR060RJOI	S0624TN0
8"	9.050	305	Yes	Yes	10.947	18.000	5.845	27.1	82157292354	OR080RJOI	S0832TN0
10"	11.100	305	Yes	Yes	13.361	18.000	5.112	39.7	82157292750	OR100RJOI	S1039TN0
12"	13.200	305	Yes	Yes	15.836	18.000	3.925	55.0	82157292347	OR120RJOI	S1246TN0

\* Includes gaskets and splines

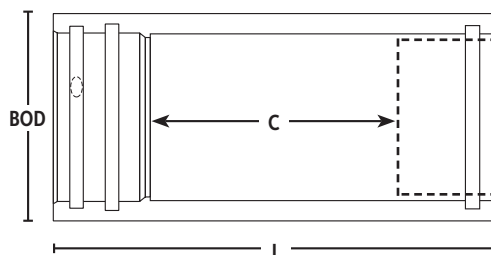

PRODUCT SPECIFICATION

# AQUACONNECT® C900 CERTA-LOK® FITTINGS

C900 CERTA-LOK® SWEEPS CERTA-LOK MALE X CERTA-LOK MALE									
Nom. Size	Pressure Rating (psi)	Certa-Lok Groove Compatibility		OD	Angle (deg)	L	W	Weight (lb)	Part Number
		C900/RJ	C900/RJIB						
4"	235	Yes	No	4.800	5	26.926	1.177	6.9	82157899509
					22.5	26.063	5.188	6.9	82157292873
					45	28.750	11.875	8.5	82157292835
					90	30.250	30.250	13.9	82157292798
6"	235	Yes	Yes	6.900	5	29.934	1.307	15.9	82157899510
					22.5	28.938	5.813	15.9	82157292880
					45	39.188	16.250	24.0	82157292842
					90	42.000	42.000	40.1	82157292453
8"	235	Yes	Yes	9.050	5	44.956	1.961	41.1	82157899511
					22.5	45.375	8.688	41.1	82157292891
					45	52.000	21.563	55.0	82157292859
					90	46.625	46.625	77.1	82157292804
10"	235	Yes	Yes	11.100	5	71.972	3.138	99.2	82157899512
					22.5	69.438	13.813	99.2	82157292903
					45	72.875	30.188	115.8	82157292378
					90	71.375	71.375	178.3	82157292811
12"	235	Yes	Yes	13.200	5	71.972	3.138	140.4	82157899513
					22.5	69.438	13.813	140.4	82157292385
					45	72.938	30.813	164.0	82157292866
					90	71.813	71.813	252.3	82157292828
16"	235	Yes	N/A	17.400	5	85.977	3.748	231.9	82157899514
					22.5	83.875	16.688	231.9	82157293252
					45	85.875	35.563	266.9	82157293245

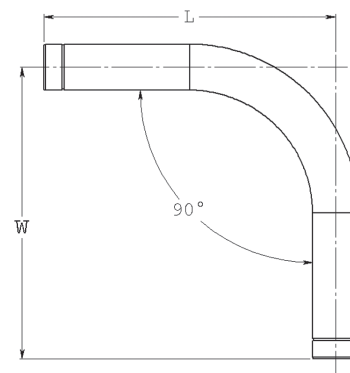
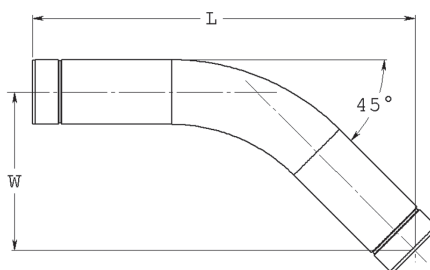
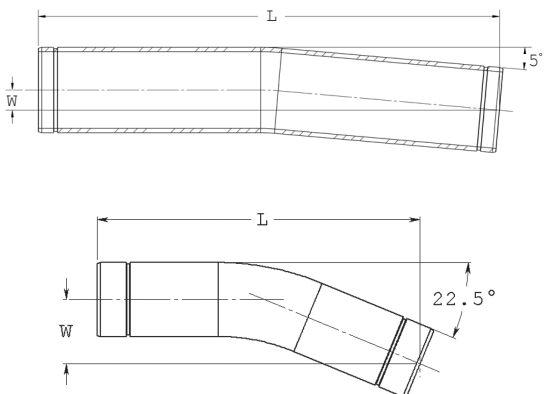

PRODUCT SPECIFICATION

# AQUACONNECT® C900 CERTA-LOK® FITTINGS

CERTA-LOK® FABRICATED ADAPTERS IB FEMALE X CERTA-LOK MALE						
Nom. Size	Part Number	DR	OD	L	Bell Depth	B
6"	82157745905	DR 18	6.900"	26.5"	13"	12.25"
8"	82157745906	DR 18	9.050"	30.5"	15.25"	14.5"
12"	82157745907	DR 18	13.200"	36.5"	17.5"	16.75"

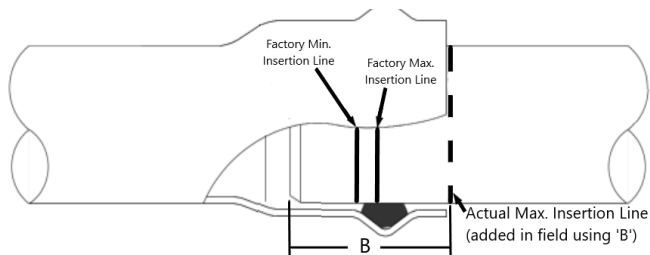
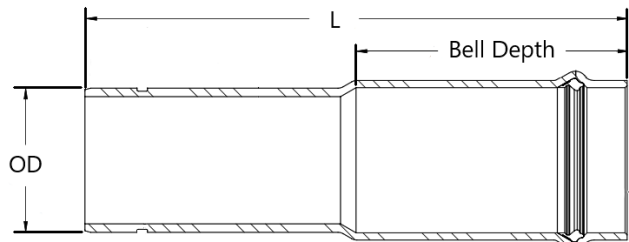

Note: A new maximum insertion line should be added to the spigot end of the non-Certa-Lok pipe based on dimension 'B' shown in the table above