



ELECTRICAL PRODUCTS

Price Lists

Westlake
Pipe & Fittings

ELECTRICAL PRODUCTS

Price Lists - Cements



Ecovoc Solvent Cement & Privoc Primer

Canadian National Price List

List No: E-ECOVOC-PLV18

Effective: March 3, 2025

Replaces: February 9, 2024

All Prices are Taxes Extra

Description	Product Code	UPC Code	Size	Carton Quantity	Carton Weight (lbs)	List Price
-------------	--------------	----------	------	-----------------	---------------------	------------

Ecovoc – Rigid PVC Conduit, Duct & ENT Solvent Cement

	RVOC250*	54790	250ml	24	18.0	\$31.00
	RVOC475*	54795	475ml	12	17.0	\$48.25
	RVOC950*	54797	950ml	12	32.5	\$67.60
	RVOC4L	54799	4L	4	41.0	\$237.90

*C/W Screw Cap & Dauber

Privoc – PVC & CPVC Primer

	RVOCPR250*	54800	250ml	24	18.0	\$31.10
	RVOCPR475*	54802	475ml	12	17.0	\$48.25
	RVOCPR950*	54804	950ml	12	32.5	\$67.40
	RVOCPR4L	54806	4L	4	41.0	\$237.90

*C/W Screw Cap & Dauber

Standards & Certifications



Ecovoc solvent cement is CSA certified for use with electrical products. Westlake Pipe & Fittings Ecovoc should always be used with Westlake Pipe & Fittings products to ensure a strong and reliable solvent weld joint.

Note: Westlake Pipe & Fittings Solvent Cements packaged in metal containers have a shelf-life of 24 months from the date of manufacture. Westlake Pipe & Fittings Primers and Cleaners packaged in metal containers have a shelf-life of 36 months from the date of manufacture.

To see our complete terms and conditions at: www.westlakepipe.com/en-ca/terms-conditions

Westlake
Pipe & Fittings

www.westlakepipe.com

© 2025 Westlake Pipe and Fittings All rights reserved. EL-PL-020-CA-EN-0325.1

ELECTRICAL PRODUCTS

Price Lists - Fittings



ENT Electrical Non-Metallic Fittings

Canadian National Price List
List No: E-80-03 ENT-PLV22
Effective: March 3, 2025
Replaces: February 9, 2024
All Prices are Taxes Extra

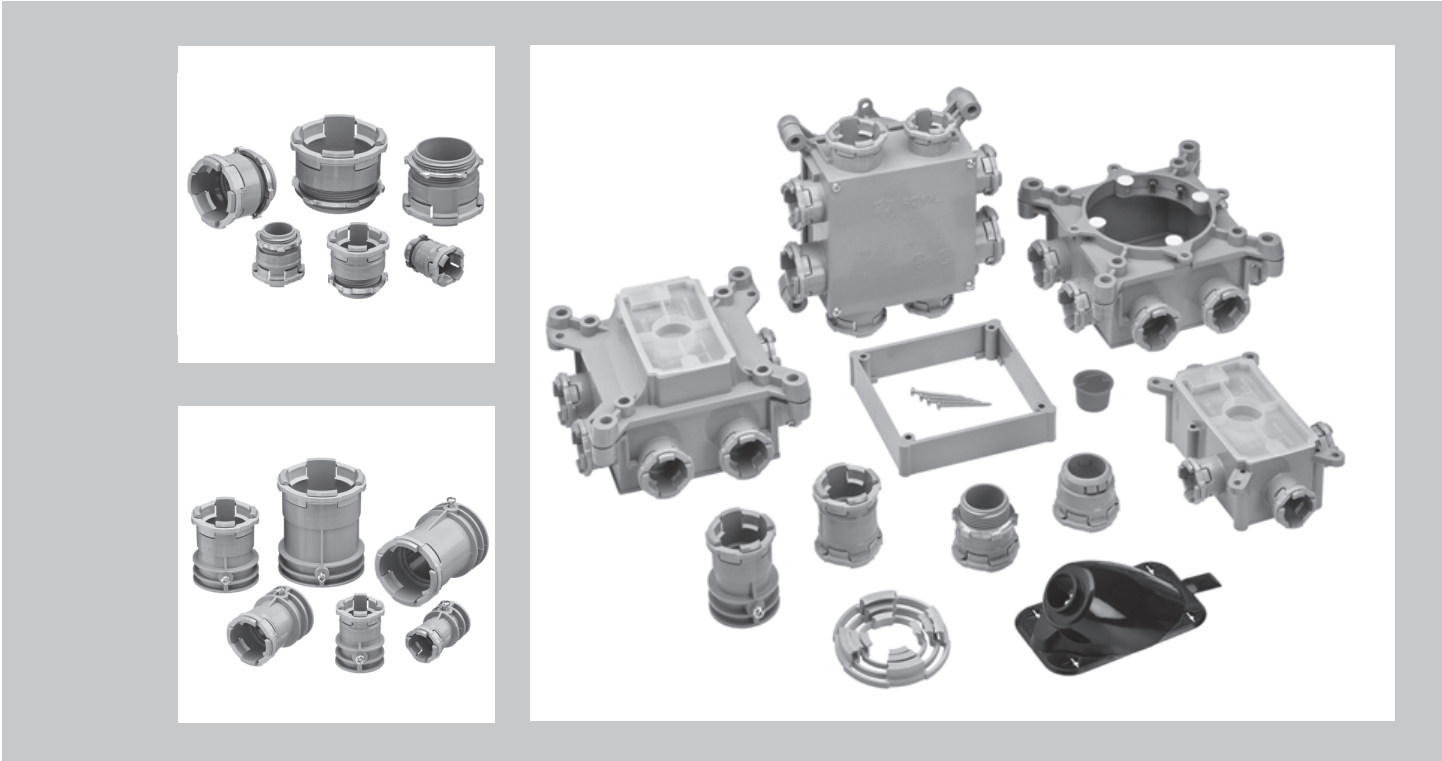

 C22.2 No. 227.1
C22.2 No. 18.2

 UL 1653
UL 514C

Electrical Non-Metallic (ENT) Fittings

Description (Fitting)	Product Code	UPC Code	Size mm (in.)	Carton Quantity	List Price
-----------------------	--------------	----------	---------------	-----------------	------------

ENT Couplings (RKC)

	RKC10	49530	12 (1/2)	150	\$833.00
	RKC15	49540	19 (3/4)	100	\$1,354.00
	RKC20	49550	25 (1)	50	\$2,172.00
	RKC25	49554	32 (1 1/4)	50	\$2,410.00
	RKC30	49556	38 (1 1/2)	40	\$2,669.00
	RKC35	49558	50 (2)	25	\$2,957.00

ENT Terminal Adapters (RKTA) (With Lock Nut)

	RKTA10	49750	12 (1/2)	150	\$608.00
	RKTA15	49760	19 (3/4)	100	\$1,026.00
	RKTA20	49770	25 (1)	50	\$1,786.00
	RKTA25	49774	32 (1 1/4)	50	\$2,410.00
	RKTA30	49776	38 (1 1/2)	50	\$2,669.00
	RKTA35	49778	50 (2)	25	\$2,957.00

ENT Quick Snap Connectors (RKTS)

	RKTS10	49700	12 (1/2)	150	\$607.00
	RKTS15	49710	19 (3/4)	100	\$1,026.00
	RKTS20	49715	25 (1)	50	\$1,786.00

ENT to EMT Adapters (RKTC)

	RKTC10	49580	12 (1/2)	125	\$867.00
	RKTC15	49590	19 (3/4)	100	\$1,428.00
	RKTC20	49600	25 (1)	50	\$2,289.00
	RKTC25	55000	32 (1 1/4)	50	\$2,537.00
	RKTC30	55002	38 (1 1/2)	40	\$2,809.00
	RKTC35	55004	50 (2)	15	\$3,115.00

ENT Clip Rings

				Bags x Pieces/Carton	Net Price Per 100 Units
	RKR10	55054	12 (1/2)	10 x 20/200	\$390.00
	RKR15	55056	19 (3/4)	10 x 20/200	\$405.00
	RKR20	55058	25 (1)	10 x 20/200	\$435.00
	RKR25	55060	32 (1 1/4)	10 x 10/100	\$465.00
	RKR30	55062	38 (1 1/2)	10 x 10/100	\$495.00
	RKR35	55064	50 (2)	10 x 5/50	\$525.00

Electrical Non-Metallic (ENT) Fittings

Description (Fitting)	Product Code	UPC Code	Size mm (in.)	Carton Quantity	List Price
-----------------------	--------------	----------	---------------	-----------------	------------

Stubbys

	RECM10	49610	12 (1/2)	150	\$774.00
	RECM15	49620	19 (3/4)	150	\$774.00
	RECM20	49630	25 (1)	200	\$930.00
	RECM25	49640	32 (1 1/4)	200	\$1,587.00

45° Angled Form Stubby

	RKASTB10	55016	12 (1/2)	50	\$971.00
	RKASTB15	55018	19 (3/4)	50	\$971.00
	RKASTB20	55020	25 (1)	50	\$1,147.00
	RKASTB25	55022	32 (1 1/4)	50	\$1,978.00
	RKASTB30	55024	38 (1 1/2)	50	\$2,172.00
	RKASTB35	55026	50 (2)	50	\$2,384.00

Tapered Plugs

	RTP10	49780	12 (1/2)	250	\$218.00
	RTP15	49790	19 (3/4)	100	\$225.00
	RTP20	49800	25 (1)	100	\$328.00

Heavy Duty Lock Nut

	RLN10	49670	12 (1/2)	200	\$70.00
	RLN15	49680	19 (3/4)	200	\$115.00
	RLN20	49690	25 (1)	200	\$200.00
	RLN25	49672	32 (1 1/4)	200	\$245.00
	RLN30	49674	38 (1 1/2)	200	\$278.00
RLN35	49676	50 (2)	200	\$317.00	

Slab Box 1" Extension Ring - With Long Screws (For use only on Standard RSMB and RSMB-H Slab Boxes - Product Reference Pages 4 and 5)

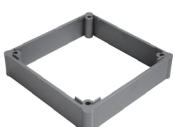
	R SMBEXTENSION	49996	-	10	\$3,747.00

Electrical Non-Metallic (ENT) Fittings

Royal Slab Ident-A-Box® - Quick Snap PVC Slab Box with Hub Extensions - Comes with Moulded Connectors and Extra Large Body Design (51.0 in3)

Description (Fitting)	Product Code	UPC Code	Size mm (in.)	Carton Quantity	List Price
-----------------------	--------------	----------	---------------	-----------------	------------

Shallow Single Gang Concrete Wall Box - with Backside Mounting Knockout

	RSVSB-H-10	55036	12 (1/2)	70	\$4,079.00
	RSVSB-H-15	55038	19 (3/4)	70	\$4,079.00
	RSVSB-H-20	55040	25 (1)	70	\$4,079.00

Deep Single Gang Concrete Wall Box

	RSVDB-H-10	55029	8 x 1/2	25	\$12,092.00
	RSVDB-H-15	55034	8 x 3/4	25	\$12,092.00
	RSVDB-H-10-15	55028	4 x 1/2 - 4 x 3/4	25	\$12,092.00
	RSVDB-H-15-20	55030	4 x 3/4 - 4 x 1	25	\$12,092.00
	RSVDB-H-10-20	55032	4 x 1/2 - 4 x 1	25	\$12,092.00
	RSVDB-H-10-15-20	55031	4 x 1/2 - 2 x 3/4 - 2 x 1	25	\$12,092.00

Square Slab Box

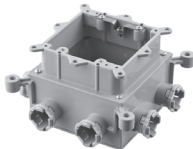
	RSSB-H-10	55070	8 x 1/2	20	\$12,092.00
	RSSB-H-15	55072	8 x 3/4	20	\$12,092.00
	RSSB-H-10-15	55074	4 x 1/2 - 4 x 3/4	20	\$12,092.00
	RSSB-H-15-20	55076	4 x 3/4 - 4 x 1	20	\$12,092.00
	RSSB-H-10-20	55078	4 x 1/2 - 4 x 1	20	\$12,092.00
	RSSB-H-10-15-20	55080	4 x 1/2 - 2 x 3/4 - 2 x 1	20	\$12,092.00

Isolator Module Slab Box - with Red Lid

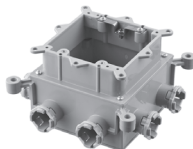
	RSMB-10-IMB	49999	8 x 1/2	20	\$13,376.00
	RSMB-15-IMB	49997	8 x 3/4	20	\$13,376.00
	RSMB-10-15-IMB	49998	4 x 1/2 - 4 x 3/4	20	\$13,376.00
	RSMB-15-20-IMB	55001	4 x 3/4 - 4 x 1	20	\$13,376.00
	RSMB-10-20-IMB	55003	4 x 1/2 - 4 x 1	20	\$13,376.00
	RSMB-10-15-20-IMB	55005	4 x 1/2 - 2 x 3/4 - 2 x 1	20	\$13,376.00

Shallow Slab Boxes

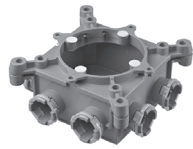
	RSMBS-H-10	55006	8 x 1/2	25	\$9,487.00
	RSMBS-H-15	55012	8 x 3/4	25	\$9,487.00
	RSMBS-H-10-15	55010	4 x 1/2 - 4 x 3/4	25	\$9,487.00
	RSMBS-H-15-20	55014	4 x 3/4 - 4 x 1	25	\$9,487.00
	RSMBS-H-10-20	55008	4 x 1/2 - 4 x 1	25	\$9,487.00
	RSMBS-H-10-15-20	55015	4 x 1/2 - 2 x 3/4 - 2 x 1	25	\$9,487.00

Slab Box with Divider Plate (Fits on Square Slab Boxes only)

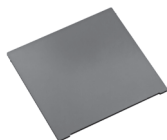
					List Price Each
	RSSBH-DC	55065	-	10 par sac	\$20.00

Electrical Non-Metallic (ENT) Fittings

Royal Slab Ident-A-Box® - Quick Snap PVC Slab Box with Hub Extensions - Comes with Moulded Connectors and Extra Large Body Design (51.0 in3)

Description (Fitting)	Product Code	UPC Code	Lid Colour	Carton Quantity	Price Per 100 Units
-----------------------	--------------	----------	------------	-----------------	---------------------

Slab Box - (8 x 1/2)

	RSMB-H-10	49720	Grey	25	\$9,487.00
	RSMB-H-10G	49721	Green	25	\$10,740.00
	RSMB-H-10B	49723	Blue	25	\$10,740.00
	RSMB-H-10Y	49724	Yellow	25	\$10,740.00
	RSMB-H-10R	49725	Red	25	\$10,740.00

Slab Box - (8 x 3/4)

	RSMB-H-15	49801	Grey	25	\$9,487.00
	RSMB-H-15G	49802	Green	25	\$10,740.00
	RSMB-H-15W	49803	White	25	\$10,740.00
	RSMB-H-15B	49804	Blue	25	\$10,740.00
	RSMB-H-15Y	49805	Yellow	25	\$10,740.00
	RSMB-H-15R	49806	Red	25	\$10,740.00

Slab Box - (4 x 1/2 - 4 x 3/4)

	RSMB-H-10-15	49730	Grey	25	\$9,487.00
	RSMB-H-10-15G	49731	Green	25	\$10,740.00
	RSMB-H-10-15W	49732	White	25	\$10,740.00
	RSMB-H-10-15B	49733	Blue	25	\$10,740.00
	RSMB-H-10-15Y	49734	Yellow	25	\$10,740.00
	RSMB-H-10-15R	49735	Red	25	\$10,740.00

Slab Box - (4 x 3/4 - 4 x 1)

	RSMB-H-15-20	49836	Grey	25	\$9,487.00
	RSMB-H-15-20G	49837	Green	25	\$10,740.00
	RSMB-H-15-20W	49838	White	25	\$10,740.00
	RSMB-H-15-20B	49839	Blue	25	\$10,740.00
	RSMB-H-15-20Y	49846	Yellow	25	\$10,740.00
	RSMB-H-15-20R	49847	Red	25	\$10,740.00

Slab Box - (4 x 1/2 - 4 x 1)

	RSMB-H-10-20	49742	Grey	25	\$9,487.00
	RSMB-H-10-20G	49841	Green	25	\$11,549.00
	RSMB-H-10-20W	49842	White	25	\$11,549.00
	RSMB-H-10-20B	49843	Blue	25	\$11,549.00
	RSMB-H-10-20Y	49844	Yellow	25	\$11,549.00
	RSMB-H-10-20R	49845	Red	25	\$11,549.00

Slab Box - (4 x 1/2 - 2 x 3/4 - 2 x 1)

	RSMB-H-10-15-20	49740	Grey	25	\$9,487.00
	RSMB-H-10-15-20G	49831	Green	25	\$11,549.00
	RSMB-H-10-15-20W	49832	White	25	\$11,549.00
	RSMB-H-10-15-20B	49833	Blue	25	\$11,549.00
	RSMB-H-10-15-20Y	49834	Yellow	25	\$11,549.00
	RSMB-H-10-15-20R	49835	Red	25	\$11,549.00

Ident-a-Box® Colour Legend

	Grey:	Generic	Blue:	Hydro - 120 Volt
	Green:	Security, Cable, Telephone	Yellow:	Emergency and Lighting Signs
	White:	Hydro - 600 Volt	Red:	Fire Alarm

Electrical Non-Metallic (ENT) Fittings

Royal Slab Ident-A-Box® - Quick Snap PVC Slab Box with Knockouts - Extra Large Body Design (51.0 in3)

Description (Fitting)	Product Code	UPC Code	Lid Colour	Carton Quantity	Price Per 100 Units
-----------------------	--------------	----------	------------	-----------------	---------------------

Slab Box - (8 x 1/2)

	RSMB-10	49852	Grey	25	\$6,648.00
	RSMB-10G	49853	Green	25	\$7,903.00
	RSMB-10W	49854	White	25	\$7,903.00
	RSMB-10B	49855	Blue	25	\$7,903.00
	RSMB-10Y	49856	Yellow	25	\$7,903.00

Slab Box - (8 x 3/4)

	RSMB-15	49870	Grey	25	\$6,648.00
	RSMB-15G	49871	Green	25	\$7,349.00
	RSMB-15W	49872	White	25	\$7,903.00
	RSMB-15B	49873	Blue	25	\$7,903.00
	RSMB-15Y	49874	Yellow	25	\$7,903.00
	RSMB-15R	49875	Red	25	\$7,903.00

Slab Box - (4 x 1/2 - 4 x 3/4)

	RSMB-10-15	49860	Grey	25	\$6,648.00
	RSMB-10-15G	49861	Green	25	\$7,903.00
	RSMB-10-15W	49862	White	25	\$7,903.00
	RSMB-10-15B	49863	Blue	25	\$7,903.00
	RSMB-10-15Y	49864	Yellow	25	\$7,903.00
	RSMB-10-15R	49865	Red	25	\$7,903.00

Slab Box - (4 x 1/2 - 2 x 3/4 - 2 x 1)

	RSMB-10-15-20	49891	Grey	25	\$6,648.00
	RSMB-10-15-20G	49892	Green	25	\$7,903.00
	RSMB-10-15-20W	49893	White	25	\$7,903.00
	RSMB-10-15-20B	49894	Blue	25	\$7,903.00
	RSMB-10-15-20Y	49895	Yellow	25	\$7,903.00
	RSMB-10-15-20R	49896	Red	25	\$7,903.00

Slab Box - (4 x 3/4 - 2 x 1/2 - 2 x 1)

	RSMB-15-20-10	49990	Grey	25	\$6,648.00
	RSMB-15-20-10G	49991	Green	25	\$7,903.00
	RSMB-15-20-10W	49992	White	25	\$7,903.00
	RSMB-15-20-10B	49993	Blue	25	\$7,903.00
	RSMB-15-20-10Y	49994	Yellow	25	\$7,903.00
	RSMB-15-20-10R	49995	Red	25	\$7,903.00

ENT Cutters - (Cutter will cut up to 1 1/4")

			Size		Price Each
	RFCUT	49560	1/2 - 1 1/4	25	\$474.00
	RFCUTBLADE	49570	Blades	1	\$207.00

Ident-a-Box® Colour Legend

	Grey:	Generic	Blue:	Hydro - 120 Volt
	Green:	Security, Cable, Telephone	Yellow:	Emergency and Lighting Signs
	White:	Hydro - 600 Volt	Red:	Fire Alarm

Electrical Non-Metallic J-Bends

Western Canada Price List
List No: E-JBND-PLV22_W
Effective: March 3, 2025
Replaces: February 9, 2024
All Prices are Taxes Extra

Standard Discount

Description (Pipe)	Product Code	UPC Code	Standard PKG	Price Per cpc (100)
J-Bends				
2" x 10' x 12" Sch 40 Rad (White)	93141	-	1	\$40,913.50
2" x 10' x 12" Sch 40 Rad (White Perf)	93142	-	1	\$44,997.00
2" x 10' x 12" Radius DBII (Orange)	93130	-	1	\$38,162.50
2" x 10' x 12" Radius Sch 40 (Grey)	REEJB2X10	-	1	\$42,950.00
3" x 5' x 24" Radius Sch 40 (Grey)	REEJB3X5	-	1	\$47,535.50
3" x 10' x 24" Radius Sch 40 (Grey)	REEJB3X10	-	1	\$61,053.00

*Bell end of J-Bend is hubbed to DBII Duct.

Please contact local sales office for availability.

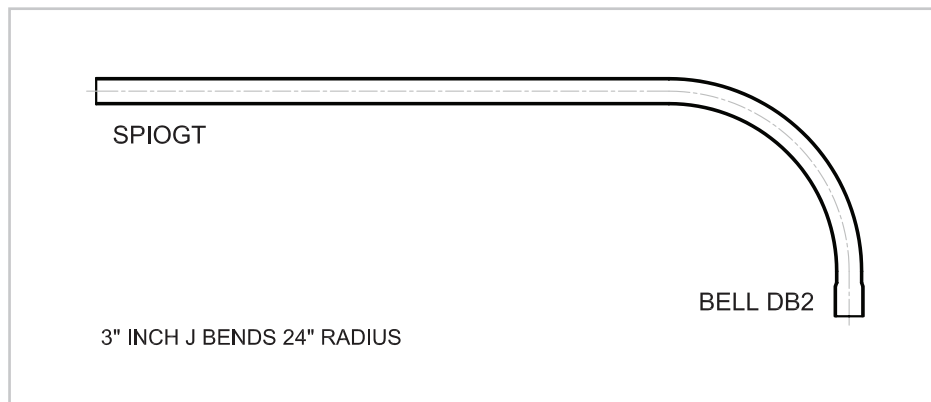

NAPBLOC™ Duct Spacers

Canadian National Price List
List No: E-MBDS-PLV22
Effective: March 3, 2025
Replaces: February 9, 2024
All Prices are Taxes Extra

Description	Product Code	Length (Inches)	Quantity Per Bundle	Quantity Per Pallet	Price Per 100	
NAPBLOC Duct Spacers						
3½ x 1 x 1 x 2	2-WAY	DMB351122	12.5	25	100	\$537.00
3½ x 1 x 1 x 2	3-WAY	DMB351123	16.9	25	100	\$1,400.00
3½ x 1 x 1 x 2	4-WAY	DMB351124	21.5	25	100	\$1,634.00
4" x 1½" x 1½" x 3"	1-WAY	DMB4151531NG	7.8	tbc	100	\$341.50
4" x 1½" x 1½" x 3"	2-WAY	DMB4151532NG	13.7	25	100	\$830.00
4" x 1½" x 1½" x 3"	3-WAY	DMB4151533NG	19.7	25	100	\$1,146.00
4" x 1½" x 1½" x 3"	4-WAY	DMB4151534NG	25.6	25	100	\$1,365.00
4 x 2 x 2 x 3	2-WAY	DMB42232	14.3	25	100	\$1,056.00
4 x 2 x 2 x 3	3-WAY	DMB42233	20.5	25	100	\$1,284.00
4 x 2 x 2 x 3	4-WAY	DMB42234	27	25	100	\$1,447.00
4" x 3"x3" x 3" *	1-WAY	DMB43331NG	9.4	tbc	100	\$454.00
4" x 3"x3" x 3" *	2-WAY	DMB43332NG	16.9	25	100	\$1,237.00
4" x 3"x3" x 3" *	3-WAY	DMB43333NG	24.4	25	100	\$1,659.00
4" x 3"x3" x 3" *	4-WAY	DMB43334NG	31.9	25	100	\$1,816.00
4½" x 2" x 2" x 3"	2-WAY	DMB452232	15.2	25	100	\$1,095.00
4½" x 2" x 2" x 3"	3-WAY	DMB452233	21.9	25	100	\$1,322.00

*190mm Spacing - Centre to Centre between Ducts

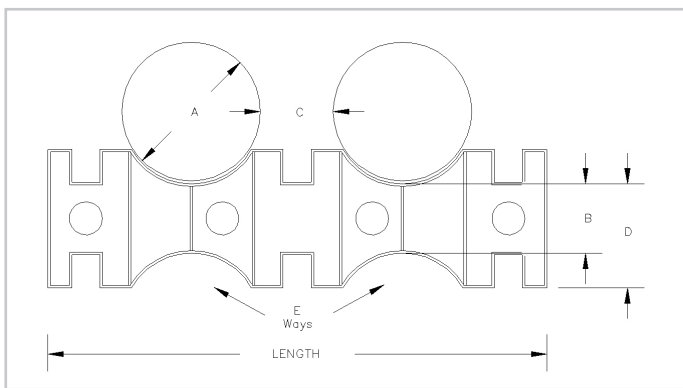

NOTE: All spacers are in an intermediate design and used for both base and intermediate applications.

Selection Table (In Inches)

Nominal Pipe Size A	Vertical Spacing B	Horizontal Spacing C	Ground Clearance D	Number of Ways E
3½	1	1	2	2, 3, 4
4	2	2	3	2, 3, 4
4	3	3	3	1, 2, 3, 4
4½	2	2	3	2, 3

To see our complete terms and conditions at: www.westlakepipe.com/en-ca/terms-conditions

Rigid PVC Conduit Fittings



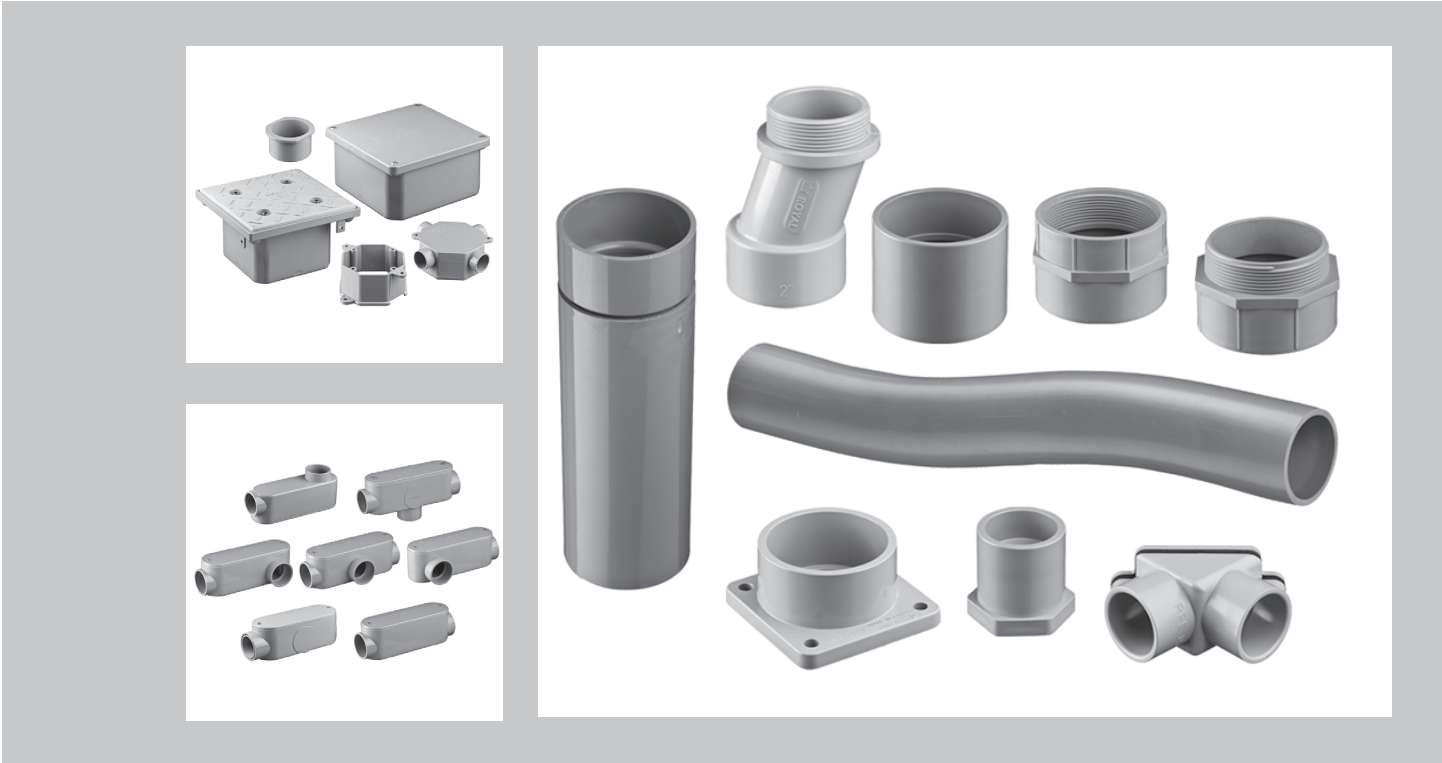

Canadian National Price List
List No: E-62-03 RCF-PLV22
Effective: March 3, 2025
Replaces: February 9, 2024
All Prices are Taxes Extra







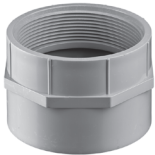

 C22.2 No. 85 Fittings

 UL 50, 514B, 514C,
514D, 651

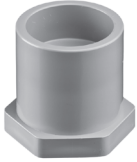
Rigid PVC Conduit Fittings

Description (Fittings)	Product Code	UPC Code	Size (in.)	Carton Quantity	Price Per 100
Coupling					
	REC10	45950	1/2	150	\$432.00
	REC15	45960	3/4	100	\$564.00
	REC20	45970	1	50	\$765.00
	REC25	45980	1 1/4	50	\$994.00
	REC30	45990	1 1/2	25	\$1,354.00
	REC35	46000	2	40	\$1,878.00
	REC40	46010	2 1/2	20	\$3,840.00
	REC45	46020	3	30	\$4,933.00
	REC50	46030	3 1/2	20	\$6,476.00
	REC55	46060	4	20	\$6,924.00
	REC60	46080	5	10	\$18,866.00
	REC65	46090	6	5	\$21,651.00
REC70	77887	8	2	\$39,188.00	
Terminal Adapter					
	RTA10	45730	1/2	200	\$497.00
	RTA15	45740	3/4	150	\$851.00
	RTA20	45750	1	100	\$934.00
	RTA25	45760	1 1/4	50	\$995.00
	RTA30	45770	1 1/2	30	\$1,798.00
	RTA35	45780	2	50	\$1,739.00
	RTA40	45790	2 1/2	25	\$4,674.00
	RTA45	45800	3	50	\$5,560.00
	RTA50	45810	3 1/2	30	\$10,812.00
	RTA55	45820	4	30	\$10,533.00
	RTA60	45830	5	12	\$23,205.00
	RTA65	45840	6	10	\$26,597.00
Female Adapter					
	RFA10	44990	1/2	150	\$588.00
	RFA15	45000	3/4	100	\$952.00
	RFA20	45010	1	50	\$1,223.00
	RFA25	45020	1 1/4	30	\$1,439.00
	RFA30	45030	1 1/2	25	\$1,870.00
	RFA35	45040	2	30	\$2,635.00
	RFA40	45050	2 1/2	20	\$4,674.00
	RFA45	45060	3	25	\$6,712.00
	RFA50	45070	3 1/2	20	\$10,812.00
	RFA55	45080	4	15	\$10,533.00
	RFA60	45090	5	10	\$23,205.00
	RFA65	45100	6	6	\$26,597.00
O'ring Expansion Joint					
	REJ10	44870	1/2	25	\$7,051.00
	REJ15	44880	3/4	25	\$7,051.00
	REJ20	44890	1	40	\$7,647.00
	REJ25	44900	1 1/4	20	\$9,227.00
	REJ30	44910	1 1/2	20	\$9,789.00
	REJ35	44920	2	10	\$12,647.00
	REJ40	44930	2 1/2	9	\$24,793.00
	REJ45	44940	3	9	\$18,743.00
	REJ50	44950	3 1/2	5	\$70,849.00
	REJ55	44960	4	5	\$83,762.00
	REJ60	44963	5	1	\$136,408.00
	REJ65	44966	6	1	\$175,047.00

Rigid PVC Conduit Fittings

Description (Fittings)	Product Code	UPC Code	Size (in.)	Carton Quantity	Price Per 100
Reducer Bushings					
	R1805	44500	3/4 x 1/2	3 x 100	\$496.00
	R1805-1	44501	1 x 1/2	3 x 100	\$981.00
	R1806	44502	1 x 3/4	2 x 100	\$705.00
	R1807-1	44505	1 1/4 x 3/4	2 x 25	\$1,030.00
	R1807	44504	1 1/4 x 1	2 x 50	\$1,256.00
	R1808-1	44507	1 1/2 x 1	50	\$1,354.00
	R1808	44506	1 1/2 x 1 1/4	50	\$1,405.00
	R1809-1	44511	2 x 1	50	\$2,361.00
	R1809	44510	2 x 1 1/4	25	\$2,635.00
	R1810	44512	2 x 1 1/2	25	\$3,214.00
	R1811	44516	2 1/2 x 2	15	\$5,612.00
	R1812-1	44530	3 x 2	25	\$6,407.00
	R1812	44520	3 x 2 1/2	15	\$8,003.00
	R1813-1	44542	4 x 2	15	\$12,940.00
R1813	44540	4 x 3	10	\$14,439.00	
R1814	44547	4 x 3 1/2	15	\$14,719.00	
Threaded Reducer Bushings (Socket and Thread)					
	R1825	44550	3/4 x 1/2	200	\$2,983.00
	R1826	44560	1 x 1/2	200	\$3,104.00
	R1827	44570	1 x 3/4	200	\$3,083.00
5° Coupling (H x H) - Fabricated					
	R5EC35	46800	2	15	\$3,399.00
	R5EC40	46805	2 1/2	12	\$5,870.00
	R5EC45	46810	3	10	\$7,655.00
	R5EC50	46815	3 1/2	15	\$14,547.00
	R5EC55	46820	4	15	\$14,582.00
	R5EC60	46825	5	4	\$23,292.00
	R5EC65	46830	6	6	\$23,292.00
	5° Coupling (H x H) - Moulded	R5ECM45	46812	3	25
R5ECM55		46822	4	25	\$26,535.00
Pull Elbow					
	RPE10	45535	1/2	50	\$2,169.00
	RPE15	45538	3/4	50	\$2,169.00
Long Meter Offset					
	RLMO25	45472	1 1/4	25	\$7,873.00
	RLMO30	45474	1 1/2	25	\$7,927.00
	RLMO35	45476	2	25	\$8,887.00
Meter Offset					
	RMO25	45500	1 1/4	40	\$2,580.00
	RMO35	45510	2	25	\$2,976.00

Rigid PVC Conduit Fittings

Description (Fittings)	Product Code	UPC Code	Size (in.)	Carton Quantity	Price Per 100
------------------------	--------------	----------	------------	-----------------	---------------

90° Elbow - Bell End



REE1090	46120	1/2	35	\$1,302.00
REE1590	46150	3/4	50	\$1,497.00
REE2090	46180	1	25	\$2,299.00
REE2590	46210	1 1/4	20	\$3,232.00
REE3090	46240	1 1/2	15	\$4,575.00
REE3590	46270	2	10	\$6,789.00
REE4090	46330	2 1/2	200	\$14,853.00
REE4590	46360	3	100	\$24,379.00
REE5090	46390	3 1/2	50	\$33,390.00
REE5590	46420	4	50	\$39,693.00
REE6090	46440	5	25	\$147,220.00
REE6590	46460	6	25	\$237,684.00
REE7090	96519	8	25	\$491,292.00

45° Elbow - Bell End

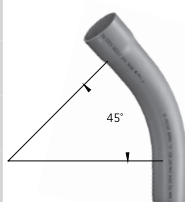

REE1045	46110	1/2	70	\$1,400.00
REE1545	46140	3/4	50	\$1,600.00
REE2045	46170	1	50	\$2,489.00
REE2545	46200	1 1/4	30	\$3,504.00
REE3045	46230	1 1/2	15	\$4,684.00
REE3545	46280	2	10	\$7,339.00
REE4045	46320	2 1/2	10	\$14,853.00
REE4545	46350	3	1	\$25,028.00
REE5045	46380	3 1/2	1	\$33,392.00
REE5545	46410	4	1	\$40,747.00
REE6045	46430	5	1	\$147,220.00
REE6545	46450	6	1	\$237,684.00
REE7045	96520	8	1	\$491,292.00

30° Elbow - Plain End



REE1030PE	46100	1/2	50	\$1,400.00
REE1530PE	46130	3/4	35	\$1,600.00
REE2030PE	46160	1	50	\$2,489.00
REE2530PE	46190	1 1/4	30	\$3,504.00
REE3030PE	46220	1 1/2	50	\$4,684.00
REE3530PE	46274	2	30	\$7,339.00
REE4030PE	46310	2 1/2	10	\$14,853.00
REE4530PE	46340	3	10	\$25,028.00
REE5030PE	46375	3 1/2	1	\$33,392.00
REE5530PE	46400	4	1	\$40,747.00
REE6030PE	46425	5	1	\$147,220.00
REE6530PE	46442	6	1	\$237,684.00
REE7030PE	96521	8	1	\$491,292.00

Utilities 90° - Elbow Bell End

Size Radius







REE2-24	46501	2 24	30	\$50,586.00
REE2-36	46502	2 36	30	\$51,004.00
REE3-24	46503	3 24	25	\$40,160.00
REE3-36	46504	3 36	25	\$64,066.00
REE4-36	46465	4 36	25	\$88,408.00
REE4-48	46505	4 48	25	\$101,287.00
REE5-36	46506	5 36	25	\$147,220.00
REE6-36	46507	6 36	25	\$237,683.00

Rigid PVC Conduit Fittings

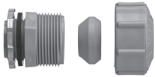
Description (Fittings)	Product Code	UPC Code	Size (in.)	Carton Quantity	Price Per 100
90° Elbow - Extended Plain End					
	REE2590E	46215	1¼	1	\$9,339.00
	REE3090E	46260	1½	1	\$9,339.00
	REE3590E	46290	2	1	\$14,167.00
Meter Hub					
	RMHU25	45480	1¼	50	\$2,697.00
	RMHU30	45485	1½	25	\$2,697.00
	RMHU35	45490	2	50	\$2,697.00
Service Entrance Fitting					
	REF10	44795	½	25	\$2,926.00
	REF15	44800	¾	25	\$2,774.00
	REF20	44810	1	15	\$3,534.00
	REF25	44820	1¼	20	\$5,432.00
	REF30	44830	1½	20	\$9,191.00
	REF35	44840	2	20	\$8,482.00
	REF40	44842	2½	2	\$54,375.00
	REF45	44844	3	2	\$52,969.00
	REF50	44852	3½	2	\$77,360.00
	REF55	44860	4	2	\$121,568.00
	Solvent Weld End Cap				
	RCAP10	44690	½	200	\$509.00
	RCAP15	44700	¾	150	\$624.00
	RCAP20	44710	1	100	\$852.00
	RCAP25	44720	1¼	40	\$1,276.00
	RCAP30	44730	1½	40	\$1,303.00
	RCAP35	44740	2	20	\$1,606.00
	RCAP40	44750	2½	15	\$3,517.00
	RCAP45	44760	3	10	\$4,766.00
	RCAP55	44770	4	12	\$10,498.00
	RCAP60	44780	5	25	\$17,978.00
	RCAP65	44782	6	10	\$24,960.00
Octagonal Box - with Integral Knockouts (*KO Plug)					
	ROB15-10	45520	4 x 1½ (¾ x ½)	20	\$5,327.00
	ROB20	45525	4 x 2 (1)	12	\$9,227.00
	RKO15*	45450	¾	1	\$335.00
Octagonal Box Extension Ring					
	RXR20	46490	1	20	\$3,534.00
	RXR35	46495	2	20	\$3,890.00
Strain Relief Connector - with 6 Grommets					
	RSRC15	45685	¾	50	\$2,887.00

Rigid PVC Conduit Fittings

Description (Fittings)	Product Code	UPC Code	Size (in.)	Carton Quantity	Price Per 100
Strain Relief Connector - with 6 Grommets, Lock Nuts and O-Rings					
	RTSRC10	45850	1/2	50	\$3,113.00
	RTSRC15	45855	3/4	50	\$4,025.00
Type 'C' Access Fitting					
	RSC10S	46600	1/2	30	\$4,787.00
	RSC20S	46605	3/4	20	\$3,104.00
	RSC30S	46610	1	15	\$3,685.00
	RSC40S	46615	1 1/4	15	\$6,629.00
	RSC50S	46620	1 1/2	10	\$10,291.00
	RSC60S	45605	2	15	\$13,065.00
	RSC70S	45606	2 1/2	4	\$40,833.00
	RSC80S	45607	3	4	\$40,833.00
	RSC90S	45608	3 1/2	4	\$70,752.00
RSC100S	45609	4	4	\$70,752.00	
Type 'LB' Access Fitting					
	RSLB10S	45620	1/2	25	\$2,430.00
	RSLB20S	45630	3/4	25	\$2,796.00
	RSLB30S	45640	1	15	\$3,638.00
	RSLB40S	45650	1 1/4	20	\$6,009.00
	RSLB50S	45660	1 1/2	10	\$7,894.00
	RSLB60S	45670	2	15	\$12,568.00
	RSLB70S	45675	2 1/2	5	\$40,708.00
	RSLB80S	45680	3	5	\$40,708.00
	RSLB90S	45681	3 1/2	5	\$70,752.00
	RSLB100S	45610	4	5	\$70,752.00
Type 'LL' Access Fitting					
	RSLL10S	46650	1/2	25	\$2,678.00
	RSLL20S	46655	3/4	20	\$2,909.00
	RSLL30S	46660	1	15	\$4,882.00
	RSLL40S	46665	1 1/4	10	\$6,629.00
	RSLL50S	46670	1 1/2	10	\$9,506.00
	RSLL60S	45682	2	10	\$15,865.00
	RSLL70S	46672	2 1/2	4	\$40,833.00
	RSLL80S	46674	3	4	\$40,833.00
	RSLL90S	46676	3 1/2	5	\$70,752.00
	RSLL100S	46678	4	5	\$70,752.00
Type 'LR' Access Fitting					
	RSLR10S	46700	1/2	25	\$2,678.00
	RSLR20S	46705	3/4	20	\$2,909.00
	RSLR30S	46710	1	15	\$4,882.00
	RSLR40S	46715	1 1/4	10	\$6,629.00
	RSLR50S	46720	1 1/2	10	\$9,506.00
	RSLR60S	45683	2	10	\$15,865.00
	RSLR70S	46725	2 1/2	4	\$40,833.00
	RSLR80S	46728	3	4	\$40,833.00
	RSLR90S	46735	3 1/2	5	\$70,752.00
	RSLR100S	46738	4	5	\$70,752.00

Rigid PVC Conduit Fittings

Description (Fittings)	Product Code	UPC Code	Size (in.)	Carton Quantity	Price Per 100
------------------------	--------------	----------	------------	-----------------	---------------

Type 'E' Access Fitting

	RSE10S	46630	½	30	\$2,525.00
	RSE20S	46632	¾	20	\$2,976.00
	RSE30S	46634	1	15	\$3,779.00
	RSE40S	46636	1¼	20	\$6,222.00
	RSE50S	46638	1½	10	\$7,894.00
	RSE60S	46640	2	15	\$13,065.00
	RSE70S	46642	2½	4	\$40,818.00
	RSE80S	46644	3	4	\$40,818.00
	RSE90S	46646	3½	4	\$70,753.00
	RSE100S	46648	4	4	\$70,753.00

Type 'T' Access Fitting

	RST10S	45690	½	30	\$4,491.00
	RST20S	45700	¾	20	\$3,006.00
	RST30S	45710	1	25	\$4,297.00
	RST40S	45720	1¼	15	\$6,626.00
	RST50S	45723	1½	10	\$8,891.00
	RST60S	45725	2	10	\$15,882.00
	RST70S	46745	2½	4	\$40,833.00
	RST80S	46748	3	4	\$40,833.00
	RST90S	46750	3½	4	\$70,752.00
	RST100S	46752	4	4	\$70,752.00

Type 'TB' Access Fitting

	RSTB10S	45692	½	30	\$11,420.00
	RSTB20S	45702	¾	20	\$11,878.00
	RSTB30S	45712	1	10	\$13,309.00
	RSTB40S	45721	1¼	10	\$15,667.00
	RSTB50S	45724	1½	15	\$18,992.00
	RSTB60S	45727	2	10	\$21,356.00
	RSTB70S	46760	2½	4	\$56,815.00
	RSTB80S	46762	3	4	\$56,815.00
	RSTB90S	46764	3½	4	\$79,195.00
	RSTB100S	46766	4	4	\$79,195.00



PVC Pipe Strap - 2 Hole

	RPS10	45540	½	4 x 100	\$192.00
	RPS15	45550	¾	4 x 100	\$241.00
	RPS20	45560	1	5 x 100	\$275.00
	RPS25	45570	1¼	8 x 50	\$356.00
	RPS30	45580	1½	9 x 25	\$405.00
	RPS35	45590	2	8 x 25	\$537.00

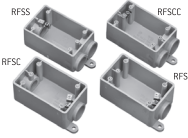
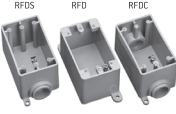
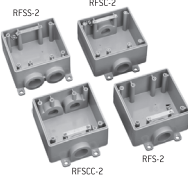

Steel Pipe Strap - 2 Hole PVC Coated

	RCS35	44783	2	50	\$1,925.00
	RCS40	44784	2½	50	\$1,967.00
	RCS45	44785	3	25	\$2,265.00
	RCS50	44786	3½	25	\$2,975.00
	RCS55	44787	4	15	\$5,282.00
	RCS60	44788	5	10	\$5,337.00
	RCS65	44789	6	5	\$12,085.00

Rigid PVC Conduit Fittings

Description (Fittings)	Product Code	UPC Code	Size (in.)	Carton Quantity	Price Per 100
Steel Pipe Strap - 1 Hole PVC Coated					
	RCS10-1	46850	1/2	250	\$1,170.00
	RCS15-1	46852	3/4	250	\$1,226.00
	RCS20-1	46854	1	100	\$1,401.00
	RCS25-1	46856	1 1/4	50	\$1,771.00
	RCS30-1	46858	1 1/2	50	\$2,129.00
	RCS35-1	46860	2	45	\$2,814.00
	RCS40-1	46862	2 1/2	25	\$5,235.00
	RCS45-1	46864	3	20	\$5,235.00
	RCS55-1	46866	4	4	\$5,797.00
Single Gang Boxes - F Series					
	RFSS10	45200	1/2" FS	10	\$4,914.00
	RFSS15	45210	3/4" FS	10	\$4,657.00
	RFSS10	45240	1/2" FSS	10	\$5,239.00
	RFSS15	45250	3/4" FSS	10	\$4,974.00
	RFSC10	45220	1/2" FSC	10	\$5,239.00
	RFSC15	45230	3/4" FSC	10	\$4,974.00
	RFSCC10	45233	1/2" FSCC	10	\$5,963.00
	RFSCC15	45235	3/4" FSCC	10	\$5,963.00
	Single Gang Deep Boxes - FD Series				
	RFDS10	45178	1/2" FDS	10	\$6,217.00
	RFDS15	45180	3/4" FDS	10	\$6,217.00
	RFDS20	45190	1" FDS	10	\$6,217.00
	RFDC10	45170	1/2" FDC	10	\$6,663.00
	RFDC15	45175	3/4" FDC	10	\$6,663.00
	RFDC20	45177	1" FDC	10	\$6,663.00
	RFD	45160	BLANK	10	\$6,748.00
	RFD347	45162	347 volt	10	\$8,995.00
	Double Gang Boxes - F Series				
	RFSS2-10	45205	1/2" FS	10	\$8,448.00
	RFSS2-15	45215	3/4" FS	10	\$8,448.00
	RFSS2-20	45216	1" FS	10	\$8,448.00
	RFSS2-10	45242	1/2" FSS	10	\$9,771.00
	RFSS2-15	45244	3/4" FSS	10	\$9,771.00
	RFSS2-20	45246	1" FSS	10	\$9,771.00
	RFSC2-10	45222	1/2" FSC	10	\$8,448.00
	RFSC2-15	45231	3/4" FSC	10	\$8,448.00
	RFSC2-20	45226	1" FSC	10	\$8,448.00
	RFSCC2-10	45234	1/2" FSCC	10	\$10,725.00
	RFSCC2-15	45238	3/4" FSCC	10	\$10,725.00
	RFSCC2-20	45239	1" FSCC	10	\$10,725.00
	RFD-2	45150	BLANK	10	\$10,491.00
	Triple Gang Boxes - F Series				
	RFSC3-10	45224	1/2" FSC	10	\$9,281.00
	RFSC3-15	45232	3/4" FSC	10	\$9,281.00
	RFSC3-20	45228	1" FSC	10	\$9,281.00
	RFSS3-10	45208	1/2" FS	10	\$9,282.00
	RFSS3-15	45218	3/4" FS	10	\$9,282.00
	RFSS3-20	45219	1" FS	10	\$9,282.00
	RFD-3	45155	BLANK	10	\$12,235.00

Rigid PVC Conduit Fittings

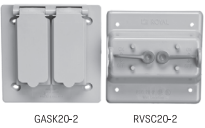
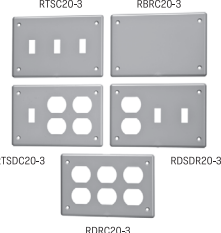
Description (Fittings)	Product Code	UPC Code	Size (in.)	Carton Quantity	Price Per 100
Single Gang Cover Plate - F Series					
	Switch	RTSC15-10	45845	100	\$2,076.00
	Duplex Receptacle	RDRC15-10	44685	100	\$2,076.00
	Single Receptacle 15 Amp	R20RC15-10	47035	100	\$2,076.00
	Single Receptacle 20 Amp	R20-3RC15-10	47036	100	\$2,076.00
	Single Receptacle 30 Amp	R30-3RC15-10	47037	100	\$2,076.00
	Blank W/Gasket	RBRC15-10	44680	100	\$2,114.00
	Single Gasket	GASK15-10	44682	1	\$337.00
Weatherproof Single Gang Cover Plate					
	Toggle	RVSC15-10	45940	20	\$8,592.00
	Plunger	RVPT15-10	45930	20	\$9,949.00
	Switch	RWTG15-10	47339	20	\$4,058.00
	Duplex	RWDR15-10	46093	20	\$4,058.00
	Duplex White	RWDR15-10W	46094	20	\$4,058.00
	Ground Fault	RWGF15-10	46095	20	\$4,058.00
	Ground Fault White	RWGF15-10W	46098	20	\$4,058.00
	15 Amp	RWTL15	46470	20	\$6,051.00
	20 Amp	RWTL20	46472	20	\$6,051.00
	30 Amp	RWTL30	46480	20	\$7,556.00
	50 Amp	RWTL50	46482	20	\$9,444.00
	Single W/P Gasket	GASK W	46484	1	\$1,127.00
Double Gang Cover Plate					
	Double Switch	RTSC20-2	45846	50	\$2,129.00
	Duplex/Switch	RTSDC20-2	45847	50	\$2,129.00
	Double Duplex	RDRC20-2	44686	50	\$2,180.00
	Double Blank W/Gasket	RBRC20-2	44681	50	\$2,975.00
	Double Gasket	GASK20-2	45949	1	\$1,152.00
Weatherproof Double Gang Cover Plate - F Series					
	Double Toggle	RVSC20-2	45941	10	\$13,553.00
	Plunger/GFI	RVSRC20-2	45947	10	\$16,329.00
	Plunger/Duplex	RVSDR20-2	45945	10	\$17,119.00
	Double Door GFI Receptacle	RVSGG20-2	-	15	\$5,173.00
	Double Door Duplex Recept.	RVSDD20-2	-	15	\$5,173.00
	Double W/P Gasket	GASK20-2	45949	1	\$1,152.00
Triple Gang Cover Plate - F Series					
	Triple Switch	RTSC20-3	45857	50	\$4,035.00
	Double Switch/Receptacle	RSDSR20-3	44689	50	\$4,035.00
	Double Receptacle/Switch	RTSDC20-3	45858	50	\$4,035.00
	Triple Receptacle	RDRC20-3	44688	50	\$3,697.00
	Triple Blank W/Gasket	RBRC20-3	44683	50	\$3,697.00
	Triple Gasket	GASK20-3	45859	1	\$1,184.00

Rigid PVC Conduit Fittings

Description (Fittings)	Product Code	UPC Code	Size (in.)	Carton Quantity	Price Per 100
------------------------	--------------	----------	------------	-----------------	---------------

Junction Box - with Gasket (Specialty Box, Any Size - P.O.A. for Zone 1,2, 3 & 4)

	RJB442	45300	4 x 4 x 2	15	\$4,435.00
	RJB444	45310	4 x 4 x 4	10	\$8,862.00
	RJB446	45315	4 x 4 x 6	8	\$14,453.00
	RJB552	45320	5 x 5 x 2	12	\$10,333.00
	RJB664	45330	6 x 6 x 4	15	\$14,384.00
	RJB666	45335	6 x 6 x 6	4	\$23,769.00
	RJB884	45340	8 x 8 x 4	4	\$24,548.00
	RJB887	45350	8 x 8 x 7	4	\$36,760.00
	RJB12124	45280	12 x 12 x 4	2	\$65,548.00
	RJB12126	45290	12 x 12 x 6	4	\$71,252.00
	RJB12128	45295	12 x 12 x 8	3	\$117,775.00

Highway Box - with Fibre Reinforced Security Lid

Price Each

	RH664	47040	6 x 6 x 4	4	\$1,072.00
	RH666	47041	6 x 6 x 6	3	\$1,152.00
	RH884	47042	8 x 8 x 4	3	\$1,786.00
	RH886	47043	8 x 8 x 6	2	P.O.R
	RH887	47044	8 x 8 x 7	2	\$1,836.00
	RH887-A	47045	8 x 8 x 7	2	\$1,878.00

Junction Box Adapters

	RJBA10	45360	1/2	100	\$984.00
	RJBA15	45370	3/4	100	\$1,146.00
	RJBA20	45380	1	100	\$2,639.00
	RJBA25	45390	1 1/4	50	\$2,697.00
	RJBA30	45400	1 1/2	50	\$2,760.00
	RJBA35	45410	2	25	\$2,783.00
	RJBA40	45420	2 1/2	10	\$3,311.00
	RJBA45	45430	3	10	\$3,987.00
	RJBA50	45435	3 1/2	10	\$4,029.00
	RJBA55	45440	4	10	\$4,039.00

Fabricated Bell Ends - Spigot End

	RFEB10	46900	1/2	200	\$5,086.00
	RFEB15	46902	3/4	150	\$4,618.00
	RFEB20	46904	1	50	\$4,618.00
	RFEB25	46906	1 1/4	35	\$4,618.00
	RFEB30	46908	1 1/2	25	\$4,618.00
	RFEB35	46910	2	10	\$8,091.00
	RFEB40	46912	2 1/2	6	\$8,091.00
	RFEB45	46914	3	12	\$12,685.00
	RFEB50	46916	3 1/2	8	\$16,270.00
	RFEB55	46918	4	4	\$17,876.00
	RFEB60	46920	5	6	\$47,439.00
	RFEB65	46922	6	10	\$47,435.00

Rigid PVC Conduit Fittings

Description (Fittings)	Product Code	UPC Code	Size (in.)	Carton Quantity	Price Per 100
------------------------	--------------	----------	------------	-----------------	---------------

Moulded Bell Ends - Spigot End Bell

	REB10	47580	1/2	100	\$4,625.00
	REB15	47581	3/4	100	\$4,625.00
	REB20	46940	1	50	\$4,625.00
	REB25	47582	1 1/4	50	\$4,625.00
	REB30	46942	1 1/2	50	\$4,625.00
	REB35	46944	2	40	\$4,625.00
	REB40	47583	2 1/2	30	\$7,356.00
	REB45	46946	3	50	\$11,530.00
	REB50	46948	3 1/2	50	\$14,777.00
	REB55	46950	4	50	\$16,240.00
	REB60	46952	5	25	\$43,076.00
	REB65	46954	6	15	\$43,076.00

Conduit Clamp

	RCCS10	55042 1	1/2	100	\$624.00
	RCCS15	55044 5	3/4	100	\$758.00
	RCCS20	55046 9	1	100	\$862.00
	RCCS25	55048 3	1 1/4	100	\$929.00
	RCCS30	55050 6	1 1/2	100	\$1,030.00
	RCCS35	55052 0	2	100	\$1,127.00

Duplex Floor Boxes and Cover (*Polycarbonate Bronze Cover)

	RFDB4	46980	4 x 3/4	-	\$42,309.00
	RFDB2	46982	2 x 3/4	-	\$42,309.00
	RFDBC*	46984	2 x 1	-	\$23,087.00
NOTE: RFDB4 Comes with 4 of 3/4" - 1/2" Bushings RFDB2 Comes with 2 of 3/4" - 1/2" Bushings					

Expansion & Deflection Fitting Assembly

					Price Each
	RSEJ35	46990	2	1	\$1,217.00
	RSEJ45	46992	3	1	\$2,020.00
	RSEJ55	46994	4	1	\$2,430.00

Conduit Shears & Blades

					Price Each
	RCUTTERHD	41855	1/2 - 1" Conduit Shears	1	P.O.R
	RCBLADES	41856	Blades-Conduit Shear Blades	1	P.O.R

All Prices are Per 100 Unless Otherwise Indicated



PVC Duct Fittings

Canadian National Price List
List No: E-72-03-UDF-PLV22
Effective: March 3, 2025
Replaces: February 9, 2024
All Prices are Taxes Extra









 C22.2 No. 211.1





PVC Duct Fittings

Description (Fitting)	Product Code	UPC Code	Size (in.)	Carton Quantity	Price Per 100
90° Long Sweep Bend					
	90B2X24	41410	2 x 24	100	\$16,185.00
	90B2X36	41416	2 x 36	100	\$19,288.00
	90B2X60	41422	2 x 60	100	\$35,715.00
	90B3X24	41464	3 x 24	100	\$38,563.00
	90B3X36	41476	3 x 36	100	\$33,431.00
	90B3X60	41494	3 x 60	100	\$55,491.00
	90B35X24	41647	3½ x 24	70	\$39,248.00
	90B35X36	41650	3½ x 36	70	\$38,563.00
	90B35X60	41653	3½ x 60	70	\$63,097.00
	90B4X24	41560	4 x 24	70	\$31,613.00
	90B4X36	41566	4 x 36	70	\$36,473.00
	90B4X60	41584	4 x 60	70	\$58,647.00
	90B5X42	41608	5 x 42	20	\$72,047.00
	90B5X60	41614	5 x 60	20	\$92,054.00
90B6X60	41638	6 x 60	15	\$117,279.00	
45° Long Sweep Bend					
	45B2X24	41392	2 x 24	100	\$12,430.00
	45B2X36	41398	2 x 36	100	\$14,597.00
	45B3X24	41434	3 x 24	100	\$21,585.00
	45B3X36	41440	3 x 36	100	\$20,787.00
	45B35X36	41452	3½ x 36	70	\$25,169.00
	45B4X24	41530	4 x 24	70	\$25,780.00
	45B4X36	41536	4 x 36	70	\$25,912.00
	45B4X60	41548	4 x 60	70	\$33,560.00
	45B5X42	41602	5 x 42	35	\$92,054.00
	45B6X60	41626	6 x 60	20	\$117,279.00
	22½° Long Sweep Bend				
	22B3X24	41428	3 x 24	-	\$23,417.00
	22B3X36	41429	3 x 36	-	\$24,644.00
	22B4X36	41512	4 x 36	-	\$25,927.00
	22B5X42	41590	5 x 42	-	\$45,655.00
Universal Plug (With Pulling Eye)					
	PLUG02	42010	2	176	\$3,210.00
	PLUG03	42016	3	200	\$5,068.00
	PLUG04	42028	4	180	\$4,534.00
	PLUG05	42040	5	100	\$4,974.00
	PLUG06	42046	6	90	\$12,091.00
	Tapered Poly Plug (With Pulling Eye)				
	DRP02	41914	2	100	\$3,210.00
	DRP03	41920	3	100	\$5,068.00
	DRP035	41926	3½	100	\$7,357.00
	DRP04	41932	4	100	\$4,534.00
	DRP05	41938	5	50	\$4,974.00
	DRP06	41944	6	35	\$12,091.00

PVC Duct Fittings

Description (Fitting)	Product Code	UPC Code	Size (in.)	Carton Quantity	Price Per 100
Reducing Coupling					
	RC3X2	41860	3 x 2	25	\$10,096.00
	RC4X2	41872	4 x 2	20	\$5,068.00
	RC4X3	41878	4 x 3	20	\$8,413.00
	RC4X3.5	41884	4 x 3½	20	\$11,650.00
	RC5X4	41890	5 x 4	20	\$20,156.00
	RC6X4	41896	6 x 4	25	\$20,699.00
Push Fit Poly Coupling					
	PFC02	41782	2	200	\$899.00
	PFC03	41788	3	100	\$1,031.00
	PFC3.5	41794	3½	150	\$1,118.00
	PFC04	41800	4	100	\$1,219.00
	PFC05	41812	5	50	\$2,630.00
	PFC06	41818	6	35	\$3,569.00
Solvent Weld PVC Coupling					
	SWC02	42232	2	25	\$1,771.00
	SWC02L	42234	2 Long	25	\$3,997.00
	SWC03	42238	3	50	\$2,021.00
	SWC03L	42239	3 Long	50	\$3,997.00
	SWC3.5	42244	3½	50	\$6,543.00
	SWC04	42250	4	40	\$2,814.00
	SWC04L	42253	4 Long	40	\$5,236.00
	SWC05	42256	5	25	\$7,629.00
SWC06	42262	6	14	\$10,096.00	
Bell End					
	BEL02	41260	2	50	\$4,079.00
	BEL03	41266	3	60	\$4,771.00
	BEL3.5	41272	3½	20	\$13,056.00
	BEL04	41278	4	60	\$5,672.00
	BEL05	41284	5	30	\$15,986.00
	BEL06	41290	6	60	\$16,804.00
Solvent Weld PVC 5° Coupling					
	SWC5 02	42274	2	-	\$6,747.00
	SWC5 03	42280	3	-	\$7,593.00
	SWC5 3.5	42286	3½	-	\$8,413.00
	SWC5 04	42292	4	40	\$6,575.00
	SWC5 05	42304	5	20	\$21,729.00
	SWC5 06	42310	6	-	\$23,909.00
Push Fit Poly 5° Coupling					
	PFC503	41824	3	100	\$3,569.00
	PFC53.5	41827	3½	90	\$3,903.00
	PFC504	41830	4	100	\$4,264.00
	PFC505	41836	5	45	\$19,775.00

PVC Duct Fittings

Description (Fitting)	Product Code	UPC Code	Size (in.)	Carton Quantity	Price Per 100
Duct Cap					
	CAP02	41296	2	25	\$3,400.00
	CAP03	41302	3	20	\$3,400.00
	CAP35	41308	3½	25	\$4,579.00
	CAP04	41314	4	50	\$3,400.00
	CAP05	41320	5	10	\$16,699.00
	CAP06	41326	6	10	\$18,475.00
Terminator Bell End Fitting (With Knockout Plug)					
	TERM35	41982	3½	-	\$8,245.00
	TERM04 (with holes)	41986	4	60	\$5,927.00
Female Adapter					
	FEMA02	41350	2	25	\$11,331.00
	FEMA03	41356	3	25	\$16,123.00
	FEMA35	41362	3½	-	\$23,537.00
	FEMA04	41368	4	20	\$13,663.00
	FEMA05	41374	5	-	\$66,362.00
	FEMA06	41380	6	-	\$76,590.00
Expansion Joint					
	EXPJ02	41332	2	-	\$80,496.00
	EXPJ03	41338	3	-	\$94,916.00
	EXPJ35	41345	3½	-	\$113,398.00
	EXPJ04	41344	4	-	\$131,884.00
Rigid PVC Conduit to DB2 Duct Adapter					
	ARIG02	41200	2	25	\$5,327.00
	ARIG03	41206	3	30	\$5,327.00
	ARIG03FAB	41207	3 Long	30	\$5,604.00
	ARIG35	41214	3½	50	\$5,355.00
	ARIG04	41218	4	40	\$5,355.00
	ARIG04FAB	41219	4 Long	40	\$5,639.00
	ARIG05	41236	5	20	\$8,722.00
ARIG06	41248	6	12	\$15,425.00	

PVC Duct Fittings

Description (Fitting)	Product Code	UPC Code	Size (in.)	Carton Quantity	Price Per 100
-----------------------	--------------	----------	------------	-----------------	---------------

Reducing Adapter Duct to Rigid PVC Conduit

	ARIG3x2	41212	3 x 2	15	\$11,389.00
	ARIG3x2L	41213	3 x 2 Long	15	\$24,182.50
	ARIG4x2	41224	4 x 2	40	\$12,703.00
	ARIG4x3	41230	4 x 3	15	\$12,703.00

Split Y

	SPLY02	41965	2	-	P.O.R
	SPLY03	41968	3	As	P.O.R
	SPLY35	41969	3½	Required	P.O.R
	SPLY04	41974	4	-	P.O.R

Intermediate Vertical Lock Spacer ("R" Denotes: Fits DBII Duct pipe only.)

	IS2015	42136	2 x 1½	350	\$2,333.00
	IS2020	42142	2 x 2	300	\$2,845.00
	IS2030	42148	2 x 3	200	\$2,765.00
	IS3015	42154	3 x 1½	225	\$2,588.00
	IS3020	42160	3 x 2	200	\$2,980.00
	IS3030	42166	3 x 3	125	\$3,216.00
	IS4010	42172	4 x 1	200	\$2,745.00
	IS4015	41902	4 x 1½	150	\$3,023.00
	IS4020	41908	4 x 2	125	\$3,277.00
	IS4030*	42190	4 x 3	90	\$3,779.00
	IS5015	42196	5 x 1½	100	\$3,277.00
	IS5020	42202	5 x 2	100	\$3,842.00
	IS5030	42208	5 x 3	80	\$4,224.00
	IS6015	42214	6 x 1½	100	\$3,892.00
	IS6020	42220	6 x 2	90	\$5,239.00
IS6030	42226	6 x 3	70	\$6,070.00	

Base Vertical Lock Spacer ("R" Denotes: Fits DBII Duct pipe only.)

	BS2015	42052	2 x 1½	250	\$2,620.00
	BS2020	42058	2 x 2	225	\$3,083.00
	BS2030	42062	2 x 3	225	\$2,951.00
	BS3015	42070	3 x 1½	175	\$3,007.00
	BS3020	42076	3 x 2	155	\$3,216.00
	BS3030	42082	3 x 3	150	\$3,216.00
	BS4010	42084	4 x 1	175	\$2,854.00
	BS4015	41848	4 x 1½	140	\$3,347.00
	BS4020	41854	4 x 2	140	\$3,539.00
	BS4030*	42094	4 x 3	120	\$3,997.00
	BS5015	42100	5 x 1½	120	\$3,692.00
	BS5020	42106	5 x 2	120	\$3,897.00
	BS5030	42112	5 x 3	100	\$4,264.00
	BS6015	42118	6 x 1½	100	\$4,298.00
	BS6020	42114	6 x 2	100	\$5,963.00
BS6030	42130	6 x 3	95	\$6,368.00	

*190mm Spacing, Centre to Centre between Ducts

ELECTRICAL PRODUCTS

Price Lists - Pipe



ENT

Electrical Non-Metallic Tubing

Canada Pipe Price List
 List No: E-ENT-PLV22
 Effective: March 3, 2025
 Replaces: February 9, 2024
 All Prices are Taxes Extra

Description (Pipe)	Product Code	UPC Code	Size mm (in.)	Feet Per Coil	Weight Per Coil	Feet Per Skid	Price Per 100 (feet)
--------------------	--------------	----------	---------------	---------------	-----------------	---------------	----------------------

ENT Coils

	EC005370	14300	12 (1/2)	370	37	4,440	\$580.00
	EC007240	14310	19 (3/4)	240	30	2,880	\$814.00
	EC010160	14320	25 (1)	160	28	1,920	\$1,187.00
	EC012500	14330	32 (1 1/4)	500	102	1,500	\$1,349.00
	EC015300	14335	38 (1 1/2)	300	72	900	\$1,880.00
	EC020225	14340	50 (2)	225	62	675	\$2,194.00

Description (Pipe)	Product Code	UPC Code	Size mm (in.)	Feet Per Bundle	Weight Per Crate	Feet Per Crate	Price Per 100 (feet)
--------------------	--------------	----------	---------------	-----------------	------------------	----------------	----------------------

ENT 10 Foot Sticks - Sold in Full Skids or Bundles

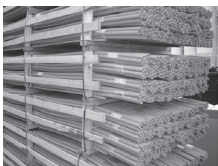
	ES00510	14325	12 (1/2)	100	390	3,600	\$571.00
	ES00710	14326	19 (3/4)	100	582	4,000	\$797.00
	ES01010	14327	25 (1)	100	457	2,400	\$1,131.00

Description (Pipe)	Product Code	UPC Code	Size mm (in.)	Feet Per Reel	Weight Per Reel	Price Per 100's
--------------------	--------------	----------	---------------	---------------	-----------------	-----------------

ENT Reels

	ER0052000	14350	12 (1/2)	2,000	250	\$580.00
	ER0071500	14360	19 (3/4)	1,500	240	\$813.00
	ER0101000	14370	25 (1)	1,000	225	\$1,187.00
	ER0121000	14380	32 (1 1/4)	1,000	198	\$1,349.00
	ER015750	14385	38 (1 1/2)	750	180	\$1,880.00
	ER020500	14390	50 (2)	500	205	\$2,194.00

Standards & Certifications



C22.2 No. 227.1



UL 1653

FT-4 Approved

Rigid PVC Conduit Pipe

Canada Pipe Price List
List No: E-RCP-PLV22
Effective: March 3, 2025
Replaces: February 9, 2024
All Prices are Taxes Extra

Size mm (in.)	Product Number		UPC Codes		Feet Per Crate L 10'	Feet Per Crate L 20'	Wt. Lbs. Per C Ft.	Price Per 100
	L 10'	L20'	L 10'	L20'				
Rigid Conduit Pipe								
12 (1/2)	RC4000510	RC4000520	15500	15510	6,000	12,000	16	\$563.00
19 (3/4)	RC4000710	RC4000720	15520	15530	4,400	8,800	22	\$703.00
25 (1)	RC4001010	RC4001020	15540	15550	3,600	7,200	32	\$1,052.00
32 (1 1/4)	RC4001210	RC4001220	15560	15570	3,300	6,600	44	\$1,318.00
38 (1 1/2)	RC4001510	RC4001520	15580	15590	2,250	4,500	52	\$1,765.00
50 (2)	RC4002010	RC4002020	15600	15610	1,400	2,800	71	\$2,203.00
63 (2 1/2)	RC4002510	RC4002520	15620	15630	780	1,560	113	\$3,811.00
75 (3)	RC4003010	RC4003020	15640	15650	780	1,560	148	\$5,006.00
90 (3 1/2)	RC4003510	RC4003520	15660	15665	630	1,260	178	\$6,283.00
100 (4)	RC4004010	RC4004020	15670	15680	600	1,200	200	\$7,073.00
125 (5)	RC4005010	RC4005020	15690	15700	230	460	286	\$10,066.00
150 (6)	RC4006010	RC4006020	15710	15715	260	520	371	\$13,380.00
200 (8)	RC4008010	RC4008020	20438	20439	140	280	559	\$21,111.00

Notes: 20 Ft. lengths are available at the same pricing as above. Each length supplied with integral bell end.

Pipe Size mm (in.)	Pieces Per Crate	Crates Per T/L		Footage Per T/L	Pounds Per T/L
		10 Ft.	20 Ft.		
12 (1/2)	600	40	20	240,000	38,400
19 (3/4)	440	48	24	211,200	46,464
25 (1)	360	36	18	129,600	41,280
32 (1 1/4)	330	32	16	105,600	46,464
38 (1 1/2)	225	40	20	90,000	37,440
50 (2)	140	40	20	56,000	39,760
63 (2 1/2)	78	40	20	31,200	44,748
75 (3)	78	32	16	24,960	41,677
90 (3 1/2)	63	32	16	20,160	35,885
100 (4)	60	32	16	19,200	38,486
125 (5)	23	32	16	7,360	30,096
150 (6)	26	32	16	8,320	30,867
200 (8)	10	32	16	3,200	18,958

Pipe Size mm (in.)	Number of Joints per Can			
	1/2 Pint (250mL)	Pint (500mL)	Quart (1/L)	Gallon (4/L)
50 (2)	17	35	70	280
75 (3)	15	30	60	240
90 (3 1/2)	13	25	50	200
100 (4)	10	20	40	160
125 (5)	8	15	30	120
150 (6)	5	10	20	80

Standards & Certifications



C22.2 No. 211.2



UL 651

FT-4 Approved 1/2" - 6"

PVC DB2 Telecommunication Duct Pipe & Fittings

Western Canada Price List
List No: E-TELDB2-PLV22_W
Effective: March 3, 2025
Replaces: February 9, 2024
All Prices are Taxes Extra

Description (Size)	Product Code	UPC Code	Price Per C'	Crate Quantity	Lbs. Per Crate
Orange Telecom Duct Pipe 10'					
1" Duct Pipe 10'	1464675	10120	\$1,442.00	1,800	584
2" Duct Pipe 10'	1464683	10130	\$1,976.00	2,460	1,070
3" Duct Pipe 10'	1464691	10140	\$2,514.00	1,120	793
4" Duct Pipe 10'	1464704	10150	\$3,575.00	630	691

Orange Telecom Duct Pipe 20'					
1" Duct Pipe 20'	1464608	10060	\$1,442.00	3,600	1,168
2" Duct Pipe 20'	1464616	10070	\$1,976.00	4,920	2,142
3" Duct Pipe 20'	1464632	10080	\$2,514.00	2,240	1,590
4" Duct Pipe 20'	1464641	10090	\$3,575.00	1,260	1,384

All above sizes are available in 10' and 20' lengths. Each size length is supplied with integral bell end.

Orange Telecom Duct Bends				
1" x 90° x 6" R	93101	-	\$4,337.00	
2" x 90° x 12" R	93112	-	\$16,525.00	
2" x 90° x 24" R	93122	-	\$18,267.00	
2" x 45° x 36" R	93060	-	\$19,858.00	
2" x 90° x 36" R	93102	-	\$19,858.00	
3" x 45° x 36" R	93062	-	\$29,723.00	
3" x 90° x 36" R	93103	-	\$33,784.00	
4" x 90° x 36" R	93104	-	\$36,858.00	
4" x 45° x 36" R	93064	-	\$32,429.00	
4" x 22½° x 12" R	93014	-	\$32,429.00	

Telecom J-Bends				
2" x 10" x 12" Radius J-Bend	93130	-	\$38,163.00	

Standards & Certifications



Please contact local sales office for availability.

PVC Duct Pipe

Canada Pipe Price List
 List No: E-UDP-PLV22
 Effective: March 3, 2025
 Replaces: February 9, 2024
 All Prices are Taxes Extra

Size mm (in.)	Lengths Per Crate	Product Number		UPC Codes		Price Per 100
		L 10'	L 20'	L 10'	L 20'	
PVC Duct Pipe - Type II						
50 (2)	246	DU02010	DU02020	16210	16200	\$1,744.00
75 (3)	112	DU03010	DU03020	16230	16220	\$2,608.00
90 (3½)	74	DU03510OR	DU03520OR	16250	16240	\$3,450.00
100 (4)	63	DU04010	DU04020	16270	16260	\$3,735.00
125 (5)	38	DU05010	DU05020	16290	16280	\$6,060.00
150 (6)	26	DU06010	DU06020	16310	16300	\$8,436.00

Notes:

- Each length bell ended.
- Available in 10 or 20 foot lengths.
- Non-standard lengths available by special order P.O.A.
- Split duct available.

Pipe Size mm (in.)	Number of Joints per Can			
	1/2 Pint (250mL)	Pint (500mL)	Quart (1/L)	Gallon (4/L)
50 (2)	17	35	70	280
75 (3)	15	30	60	240
90 (3½)	13	25	50	200
100 (4)	10	20	40	160
125 (5)	8	15	30	120
150 (6)	5	10	20	80

Standards & Certifications

