

SIGNED DRAWINGS MUST ACCOMPANY PURCHASE ORDER OR DIMENSIONS OF FITTINGS WILL NOT BE GUARANTEED

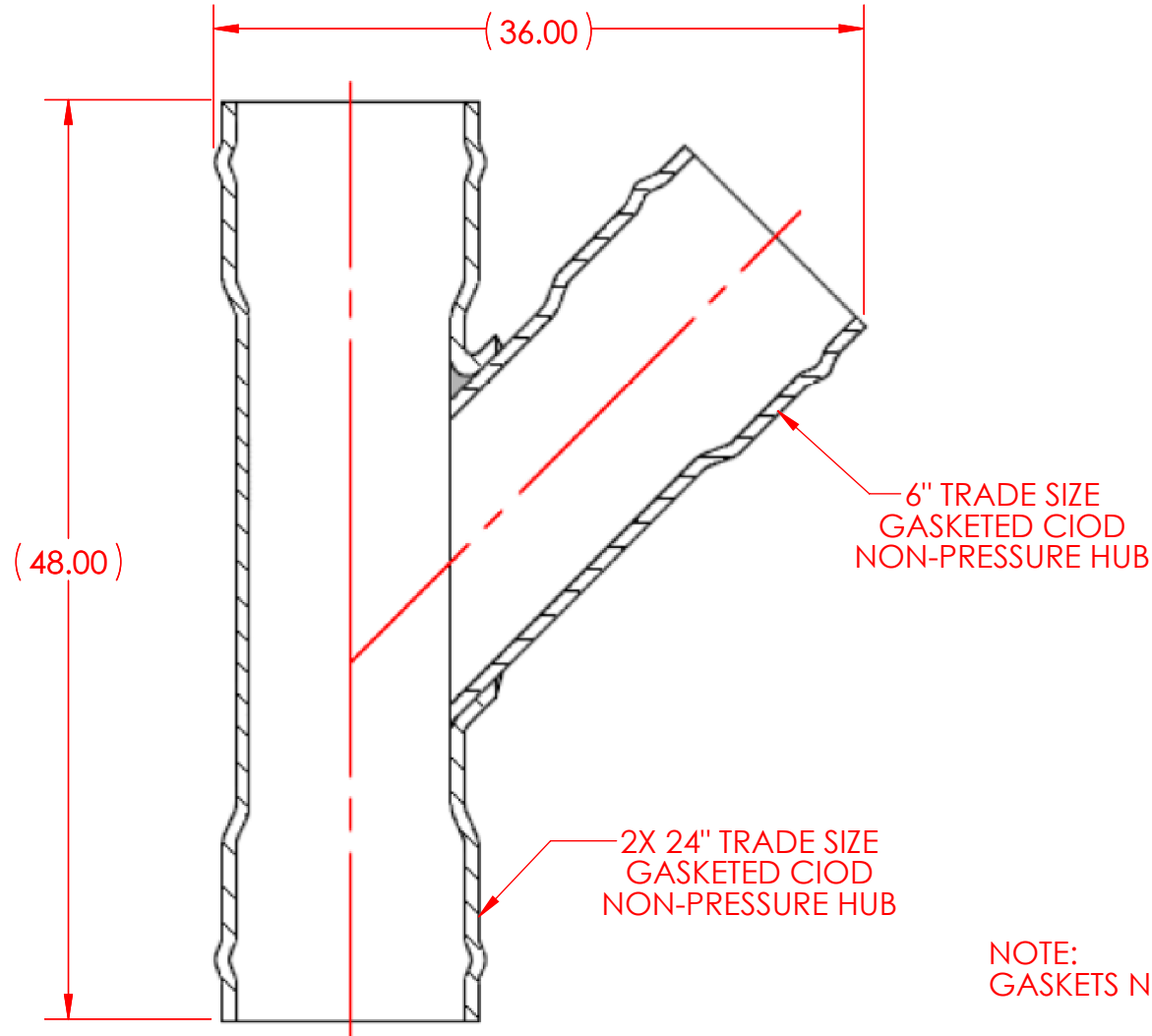

NOTE:  
GASKETS NOT SHOWN

**DISCLAIMER - PLEASE READ**

- DIMENSIONS AND APPEARANCE ARE APPROXIMATE AND SUBJECT TO CHANGE WITHOUT NOTICE DUE TO DESIGN OR PRODUCTION MODIFICATIONS
- ANGLE TOLERANCE IS +/- 2 DEGREES.
- ALL OTHER DIMENSIONS ARE TO TOLERANCES OF +/- 1"
- ALL FITTINGS ARE SUBJECT TO NAPCO "STANDARD TERMS AND CONDITIONS"

REF.  
01CN242406GGG  
01CN---GGG-SPEC

**NAPCO** PIPE & FITTINGS

56400 Mound Road  
Shelby Township, MI 48316  
U.S.A.  
Phone (800) 232-5690 | Fax (586) 781-0888  
CSshelby@napcopipe.com | www.napcopipe.com

**24" 45 DEGREE WYE with 6" BRANCH (C900xC900)  
PVC GASKETED CIOD NON-PRESSURE (DR18)**

**24"x 24"x 6" GxGxG**

PRINTED COPIES ARE FOR REFERENCE ONLY

DATE: 6/27/2022 DRAWN BY: RSS

DATE: 6/27/2022 CHECKED BY: WPF

N25-3024-6.L

CUSTOMER