

SIGNED DRAWINGS MUST ACCOMPANY PURCHASE ORDER OR DIMENSIONS OF FITTINGS WILL NOT BE GUARANTEED

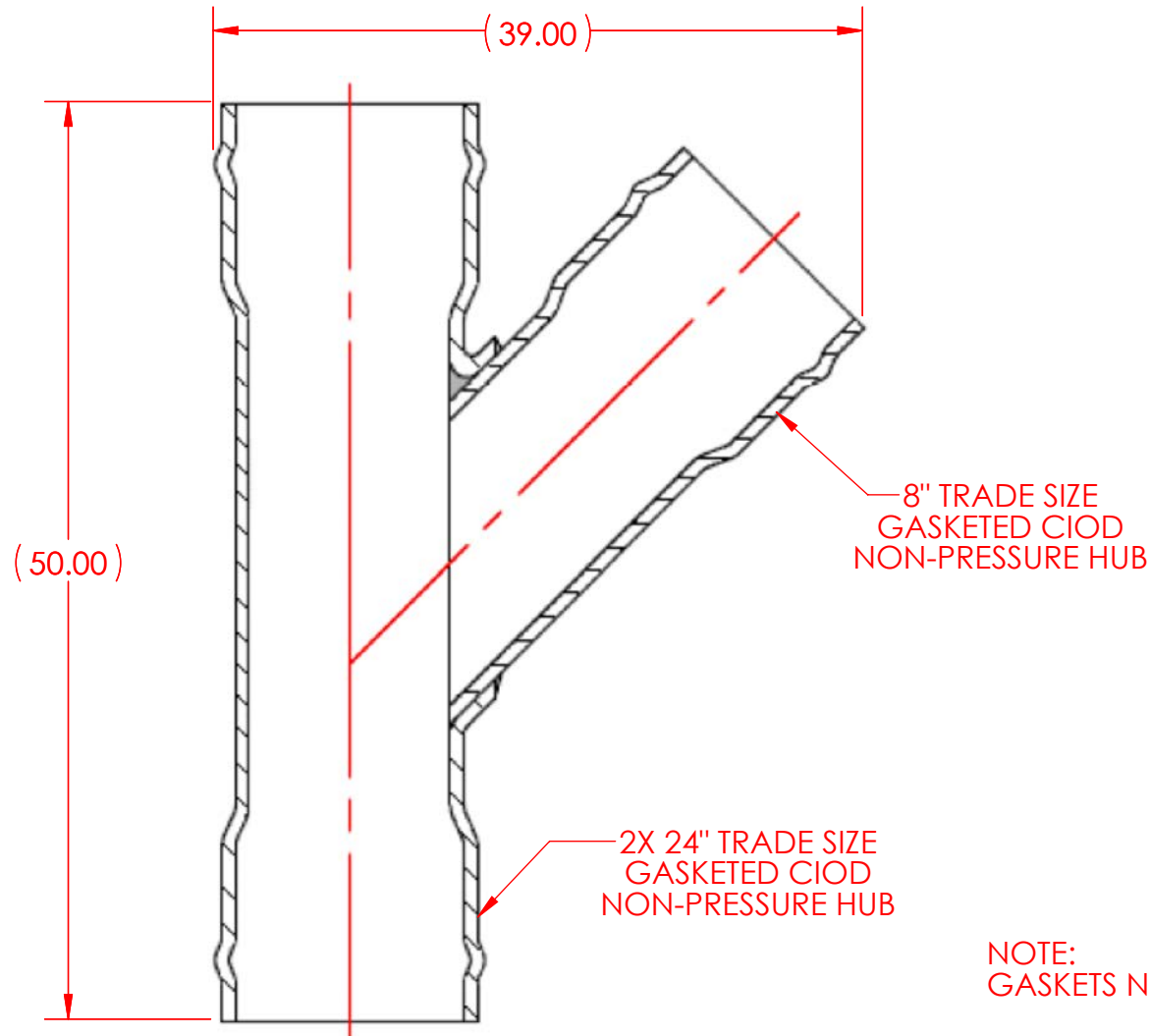

DISCLAIMER - PLEASE READ

- DIMENSIONS AND APPEARANCE ARE APPROXIMATE AND SUBJECT TO CHANGE WITHOUT NOTICE DUE TO DESIGN OR PRODUCTION MODIFICATIONS
- ANGLE TOLERANCE IS +/- 2 DEGREES.
- ALL OTHER DIMENSIONS ARE TO TOLERANCES OF +/- 1"
- ALL FITTINGS ARE SUBJECT TO NAPCO "STANDARD TERMS AND CONDITIONS"

REF.
01CN242408GGG
01CN---GGG-SPEC

NAPCO PIPE & FITTINGS

56400 Mound Road
Shelby Township, MI 48316
U.S.A.
Phone (800) 232-5690 | Fax (586) 781-0888
CSshelby@napcopipe.com | www.napcopipe.com

**24" 45 DEGREE WYE with 8" BRANCH (C900xC900)
PVC GASKETED CIOD NON-PRESSURE (DR18)**

24"x 24"x 8" GxGxG

PRINTED COPIES ARE FOR REFERENCE ONLY

DATE: 6/27/2022 DRAWN BY: RSS
DATE: 6/27/2022 CHECKED BY: WPF

N25-3024-8.L

CUSTOMER