

SIGNED DRAWINGS MUST ACCOMPANY PURCHASE ORDER OR DIMENSIONS OF FITTINGS WILL NOT BE GUARANTEED

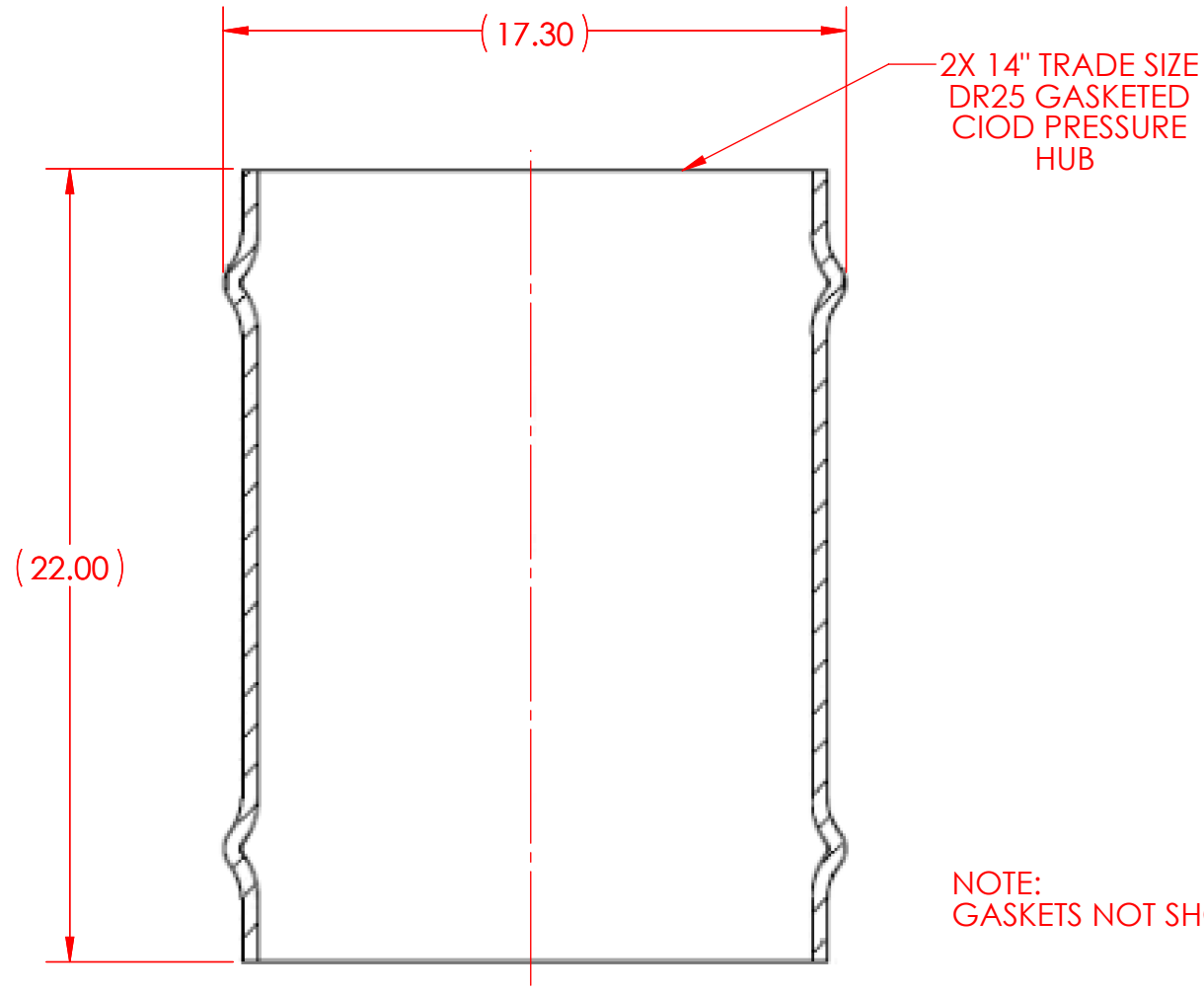

NOTE:  
GASKETS NOT SHOWN

**DISCLAIMER - PLEASE READ**

- DIMENSIONS AND APPEARANCE ARE APPROXIMATE AND SUBJECT TO CHANGE WITHOUT NOTICE DUE TO DESIGN OR PRODUCTION MODIFICATIONS
- ANGLE TOLERANCE IS +/- 2 DEGREES.
- ALL OTHER DIMENSIONS ARE TO TOLERANCES OF +/- 1"
- ALL FITTINGS ARE SUBJECT TO NAPCO "STANDARD TERMS AND CONDITIONS"

REF.  
33CCOUP14GG25  
33CCOUP--GG-SPEC

**NAPCO** PIPE & FITTINGS

56400 Mound Road  
Shelby Township, MI 48316  
U.S.A.  
Phone (800) 232-5690 | Fax (586) 781-0888  
CSshelby@napcopipe.com | www.napcopipe.com

**14" REPAIR COUPLING**  
**PVC DR25 GASKETED CIOD PRESSURE**  
**14"x 14" GxG**

PRINTED COPIES ARE FOR REFERENCE ONLY

DATE: 3/8/2022      DRAWN BY: GEB  
DATE: 3/8/2022      CHECKED BY: RSS

C25-6214.L

CUSTOMER