

SIGNED DRAWINGS MUST ACCOMPANY PURCHASE ORDER OR DIMENSIONS OF FITTINGS WILL NOT BE GUARANTEED

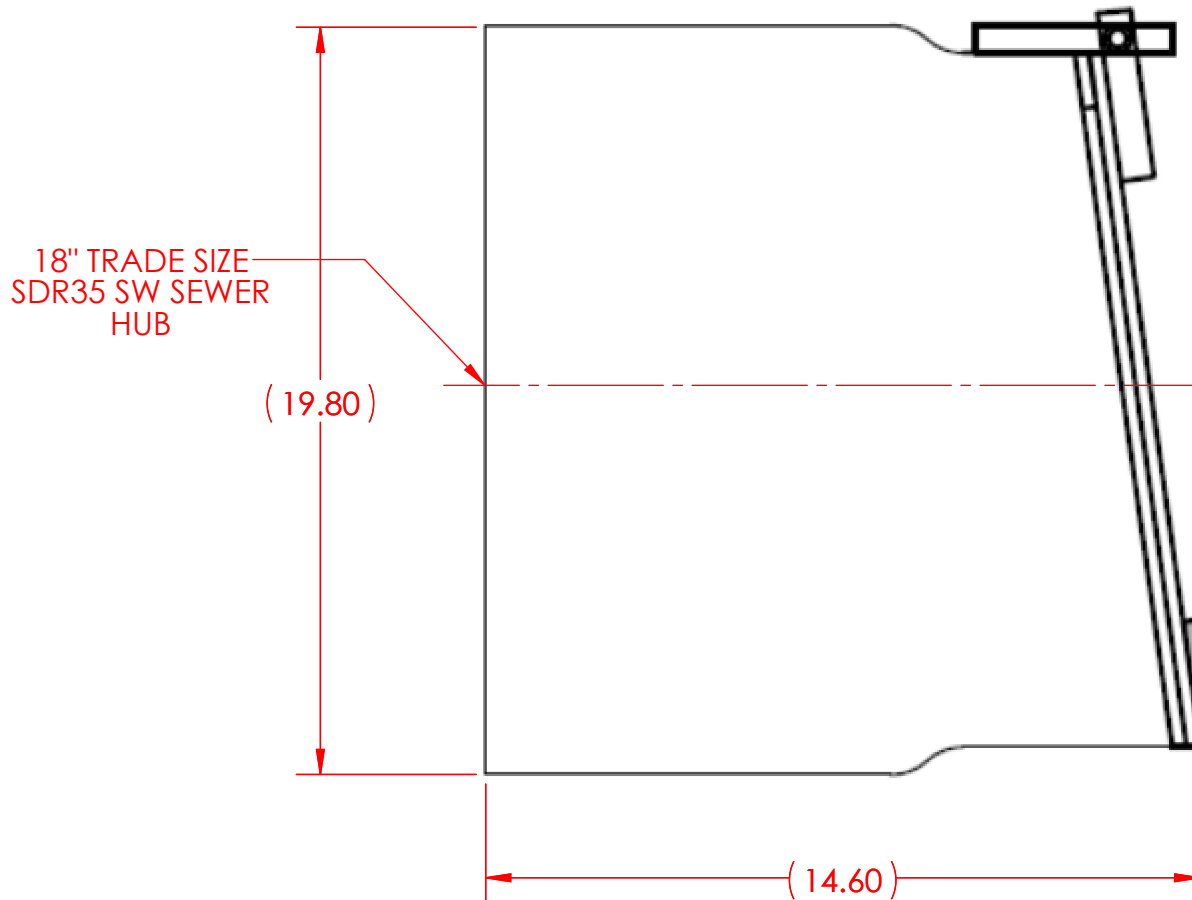

**DISCLAIMER - PLEASE READ**

- DIMENSIONS AND APPEARANCE ARE APPROXIMATE AND SUBJECT TO CHANGE WITHOUT NOTICE DUE TO DESIGN OR PRODUCTION MODIFICATIONS
- ANGLE TOLERANCE IS +/- 2 DEGREES.
- ALL OTHER DIMENSIONS ARE TO TOLERANCES OF +/- 1"
- ALL FITTINGS ARE SUBJECT TO RBP "STANDARD TERMS AND CONDITIONS"

REF.  
79ATBWV18H  
79ATBWV--H-SPEC

**NAPCO** PIPE & FITTINGS

56400 Mound Road  
Shelby Township, MI 48316  
U.S.A.  
Phone (800) 232-5690 | Fax (586) 781-0888  
CSshelby@napcopipe.com | www.napcopipe.com

**18" TERMINAL BACKWATER VALVE (H)**  
**PVC SDR35 SW SEWER**  
**18"x 18" (H)**

PRINTED COPIES ARE FOR REFERENCE ONLY

DATE: 5/13/2021      DRAWN BY: GEB  
DATE: 5/13/2021      CHECKED BY: RSS

P0218.L