

SIGNED DRAWINGS MUST ACCOMPANY PURCHASE ORDER OR DIMENSIONS OF FITTINGS WILL NOT BE GUARANTEED

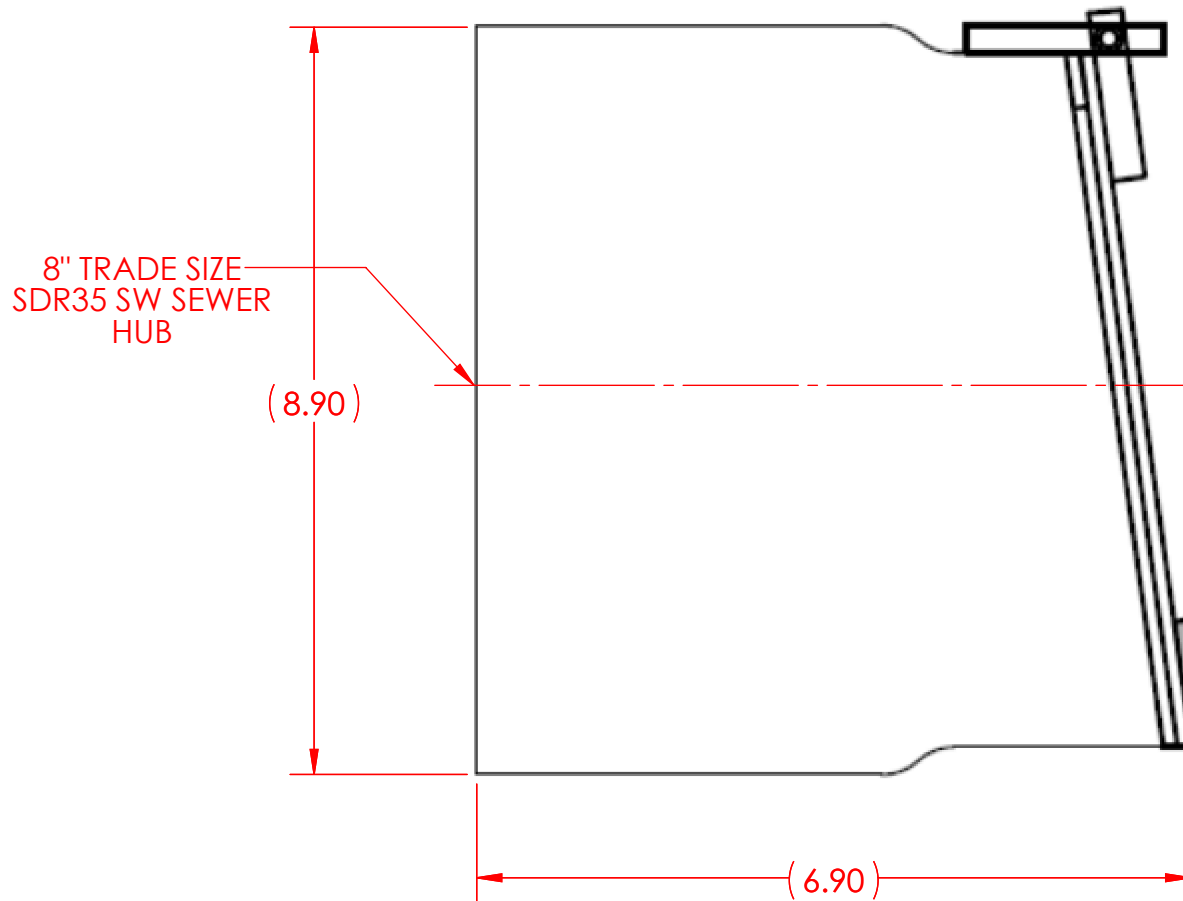

DISCLAIMER - PLEASE READ

- DIMENSIONS AND APPEARANCE ARE APPROXIMATE AND SUBJECT TO CHANGE WITHOUT NOTICE DUE TO DESIGN OR PRODUCTION MODIFICATIONS
- ANGLE TOLERANCE IS +/- 2 DEGREES.
- ALL OTHER DIMENSIONS ARE TO TOLERANCES OF +/- 1"
- ALL FITTINGS ARE SUBJECT TO RBP "STANDARD TERMS AND CONDITIONS"

REF.
79ATBWV08H
79ATBWV--H-SPEC

NAPCO PIPE & FITTINGS

56400 Mound Road
Shelby Township, MI 48316
U.S.A.
Phone (800) 232-5690 | Fax (586) 781-0888
CSshelby@napcopipe.com | www.napcopipe.com

8" TERMINAL BACKWATER VALVE (H)
PVC SDR35 SW SEWER
8"x 8" (H)

PRINTED COPIES ARE FOR REFERENCE ONLY

DATE: 5/13/2021 DRAWN BY: GEB
DATE: 5/13/2021 CHECKED BY: RSS

P0208.L

CUSTOMER